

# VOLLEYBALL CATALOG

	PAGE(S)
Volleyball Surfaces .....	2
Court Layout .....	3
Court Curbing .....	4-5
Volleyball Net Systems .....	6-14
Badminton Net System .....	12
Base Pads, Antennas & Boundary Tape .....	14
Volleyball Nets .....	15
Net Keepers .....	16
Custom Volleyball Net Tape .....	16
Referee Stands .....	17
Custom Volleyball Padding .....	18
Equipment Carriers .....	18
Floor Sleeves & Covers .....	19
Floor Anchors & Wall Racks .....	20
Ball Carriers .....	21
System Replacement Parts .....	21
Volleyball Training Equipment .....	22
Sand Volleyball Grooming Tools: Rakes, Loop Hoe Edger, Sand Comb, Sifting Scoop .....	23
Volleyballs .....	24-25
Dri-Ball Drying Agent .....	26



**YOUR “ONE-STOP” SOURCE FOR AMERICA’S BASEBALL, SOFTBALL & SPORTS SURFACES & SUPPLIES!**

*PRICES SUBJECT TO CHANGE & AVAILABILITY PLUS SHIPPING | VOLUME DISCOUNTS AVAILABLE | COOPERATIVE PURCHASING CONTRACT PRICING FOR 50 STATES*

**PARTAC PEAT CORPORATION**  
 ONE KELSEY PARK, GREAT MEADOWS, NEW JERSEY 07838

800-247-BEAM (2326) • (908) 637-4191 • FAX (908) 637-8421  
 www.beamclay.com • sales@beamclay.com  
 Bid Term - 5/9/18 - 5/8/20; Extended to 5/8/21; Extended to 5/8/22

# BEAM CLAY®

## WHOLESALE PRICE LIST EFFECTIVE: JANUARY 1, 2021

### Volleyball

#### VOLLEYBALL SURFACES

WHITE BEACH SANDS FOR VOLLEYBALL Washed, Screened Silica Sands.		TO GET APPROX PRICE/CU. YD. MULTIPLY BY 1.2	BULK PER TON		PER 50 LB. BAG
<b>White / Medium</b> <i>Approximately 85% between .25mm - 1.0mm</i>					
<i>South Jersey Plant</i>	<b>WM-SJB</b>	\$25			—
<i>North Jersey Plant</i>	<b>WM-NJB</b>	\$45			—
<b>White / Medium—Double Screened</b> <i>Approximately 85% between .25mm - 1.0mm</i>					
<i>North Jersey Plant</i>	<b>WM-DS-NJB</b>	\$48	<b>WM-DS-NJBAG</b>	\$5.25	
<b>White / Medium / Heat-Treated</b> <i>Approximately 85% between .25mm - 1.0mm</i>					
<i>North Jersey Plant</i>	<b>WM-HT-NJB</b>	\$69	<b>WM-HT-NJBAG</b>	\$5.50	
<b>White / Fine</b>					
<i>South Jersey Plant</i>	<b>WF-SJB</b>	\$55			—
<b>White / Very Fine</b> <i>Approximately 90% between .15mm - .4mm</i>					
<i>South Jersey Plant</i>	<b>WVF-SJB</b>	\$25			—
<b>Extra-White / Fine</b> <i>Approximately 75% between .25mm - 1.0mm</i>					
<i>North Jersey Plant</i>		—	<b>XWF-NJBAG</b>	\$5.50	
<b>White / Extra-Fine</b> <i>Approximately 75% between .25mm - 1.0mm</i>					
<i>South Jersey Plant</i>	<b>WEF-SJB</b>	\$27			—
<b>White / Medium-Fine</b>					
<i>South Jersey Plant</i>	<b>WMF-SJB</b>	\$27			—
<b>White / Medium-Coarse</b>					
<i>South Jersey Plant</i>	<b>WMC-SJB</b>	\$29			—
<b>Bright White Crushed Marble / Medium-Coarse</b> <i>.25mm - 1.0mm</i>					PER 3,000 LB/ BULK BAG
<i>MA Plant</i>	<b>SW-MC-MAB</b>	\$50			
<b>White / Heat Treated - 30/50**</b> <i>Approximately 95% between .25mm—1mm, 100% passing 2mm)</i>					
<i>South Jersey Plant</i>	<b>WHT3050-SJB</b>	\$88	<b>WHT3050-SJBB</b>	\$300	
<b>White / Heat Treated - 20/40**</b> <i>Approximately 98% between .25mm—1mm, predominantly .5—1mm, 100% passing 2mm)</i>					
<i>South Jersey Plant</i>	<b>WHT2040-SJB</b>	\$90	<b>WHT2040-SJBB</b>	\$310	
<b>White / Heat Treated - 16/30**</b> <i>Approximately 98% between .25mm—1mm, predominantly .25—1mm, 100% passing 2mm)</i>					
<i>South Jersey Plant</i>	<b>WHT1630-SJB</b>	\$100	<b>WHT1630-SJBB</b>	\$415	
<b>White / Heat Treated - 18/60*</b> <i>slightly broader range than 30/50</i> <i>Approximately 90% between .25mm—1mm, predominantly .5—1mm, 100% passing 2mm)</i>					
<i>South Jersey Plant</i>	<b>WHT1860-SJB</b>	\$70	<b>WHT1860-SJBB</b>	\$198	
<b>White / Heat Treated - 18/100*</b> <i>Approximately 85% between .25mm—1mm, predominantly .25—1mm, 100% passing 2mm)</i>					
<i>South Jersey Plant</i>	<b>WHT18100-SJB</b>	\$65	<b>WHT18100-SJBB</b>	\$175	
<b>White / Heat Treated - 35/70*</b> <i>Approximately 85% between .25mm—1mm, predominantly .25—.5mm, 100% passing 2mm)</i>					
<i>South Jersey Plant</i>	<b>WHT3570-SJB</b>	\$70	<b>WHT3570-SJBB</b>	\$190	
<b>White / Heat Treated - 35/100*</b> <i>Approximately 85% between .25mm—1mm, predominantly .25—.5mm, 100% passing 2mm)</i>					
<i>South Jersey Plant</i>	<b>WHT35100-SJB</b>	\$50	<b>WHT35100-SJBB</b>	\$170	
<b>White / Heat Treated - 40/100**</b> <i>Approximately 70% between .25mm—1mm, predominantly .25—.5mm, 100% passing 2mm)</i>					
<i>South Jersey Plant</i>	<b>WHT40100-SJB</b>	\$88	<b>WHT40100-SJBB</b>	\$335	

Most Popular



\* Minimum Order: 1 Pallet  
\*\* Minimum Order: 11 Tons in Bulk or 4 Pallets of Bulk Bags

PALLET & COVER CHARGES: \$6.50/PALLET. #NJ-PALLET

**YOUR “ONE-STOP” SOURCE FOR AMERICA’S BASEBALL, SOFTBALL & SPORTS SURFACES & SUPPLIES!**

PRICES SUBJECT TO CHANGE & AVAILABILITY PLUS SHIPPING | VOLUME DISCOUNTS AVAILABLE | COOPERATIVE PURCHASING CONTRACT PRICING FOR 50 STATES

# BEAM CLAY®

## WHOLESALE PRICE LIST

Volleyball

### VOLLEYBALL COURT LAYOUT

#### NAME OF SPORTS ORGANIZATION

United States Volleyball Association

#### RECOMMENDED AREA

Ground space is 4,000 square feet.

#### SIZE AND DIMENSION

Playing court is 30' x 60' plus 6' minimum, 10' preferred, unobstructed space on all sides.

#### ORIENTATION

Preferred orientation is for the long axis to be north/south.

#### SURFACE AND DRAINAGE

Recommended surface for intensive use is to be bituminous material or concrete, but sand-clay or turf may be used for informal play. Drainage is to be end to end, side to side or corner to corner at a minimum slope of 1" in 10'.

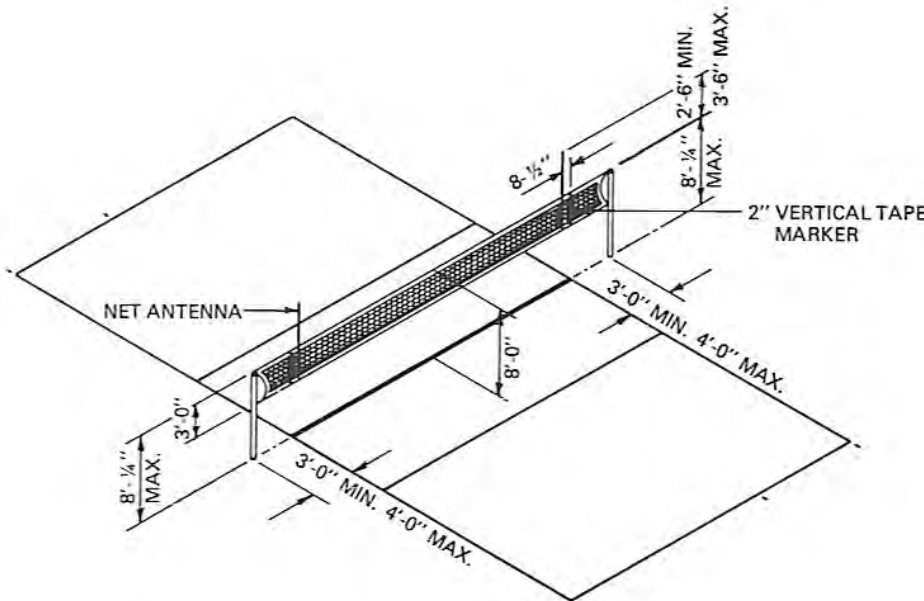
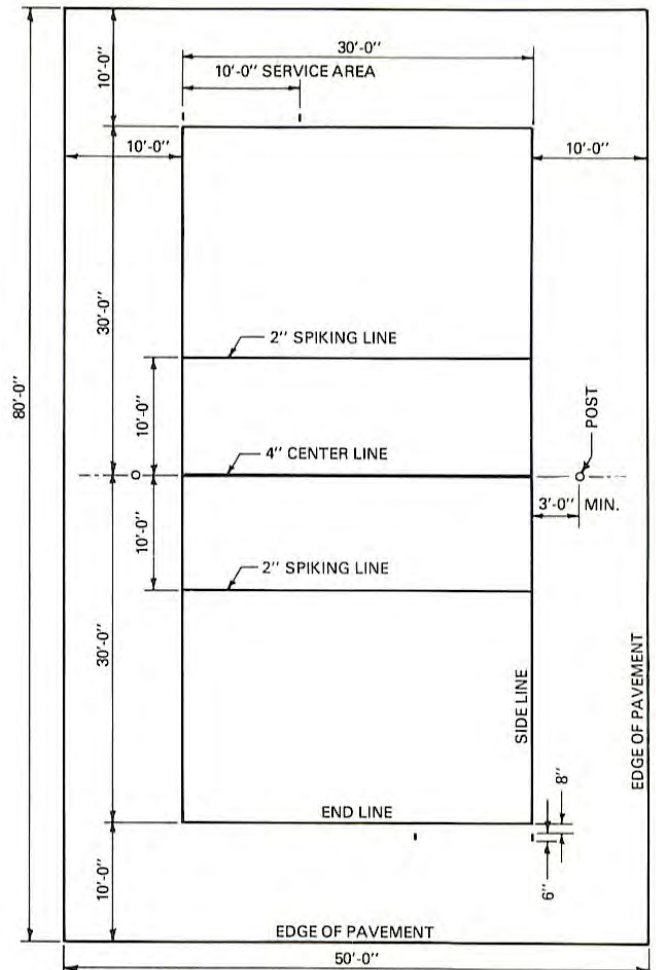

#### NOTES

ALL MEASUREMENTS FOR COURT MARKINGS ARE TO THE OUTSIDE OF LINES EXCEPT FOR THE CENTER LINE.

ALL COURT MARKINGS TO BE 2" WIDE EXCEPT AS NOTED.

#### NET HEIGHT AT CENTER

- MEN 8'-0"
- WOMEN 7'-4-1/4"
- HIGH SCHOOL 7'-0"
- ELEMENTARY SCHOOL 6'-6"

**YOUR "ONE-STOP" SOURCE FOR AMERICA'S BASEBALL, SOFTBALL & SPORTS SURFACES & SUPPLIES!**

PRICES SUBJECT TO CHANGE & AVAILABILITY PLUS SHIPPING | VOLUME DISCOUNTS AVAILABLE | COOPERATIVE PURCHASING CONTRACT PRICING FOR 50 STATES

# BEAM CLAY®

Volleyball Rubber Curbing

**WHOLESALE PRICE LIST**  
 EFFECTIVE: JULY 1, 2021

## VOLLEYBALL RUBBER CURBING

PER PIECE

4" High x 4" Wide x 6' Long (30 lbs./piece, up to 99 pieces/pallet)	#RC-4X4X6	\$35
6" High x 4" Wide x 6' Long (45 lbs./piece, up to 63 pieces/pallet)	#RC-6X4X6	\$65
8" High x 4" Wide x 6' Long (70 lbs./piece, up to 45 pieces/pallet)	#RC-8X4X6	\$82
4" High x 3" Wide x 6' Long (20 lbs./piece, up to 100 pieces/pallet)	#RC-4X3X6	\$36
4" High x 3" Wide x 4' Long (13 lbs./piece, up to 140 pieces/pallet)	#RC-4X3X4	\$20

*Please note: The 4" wide sections are grooved and can be stacked to create desired height.. However, the 3" W is not stackable. 3" W lengths of curbing are not grooved for stacking.*

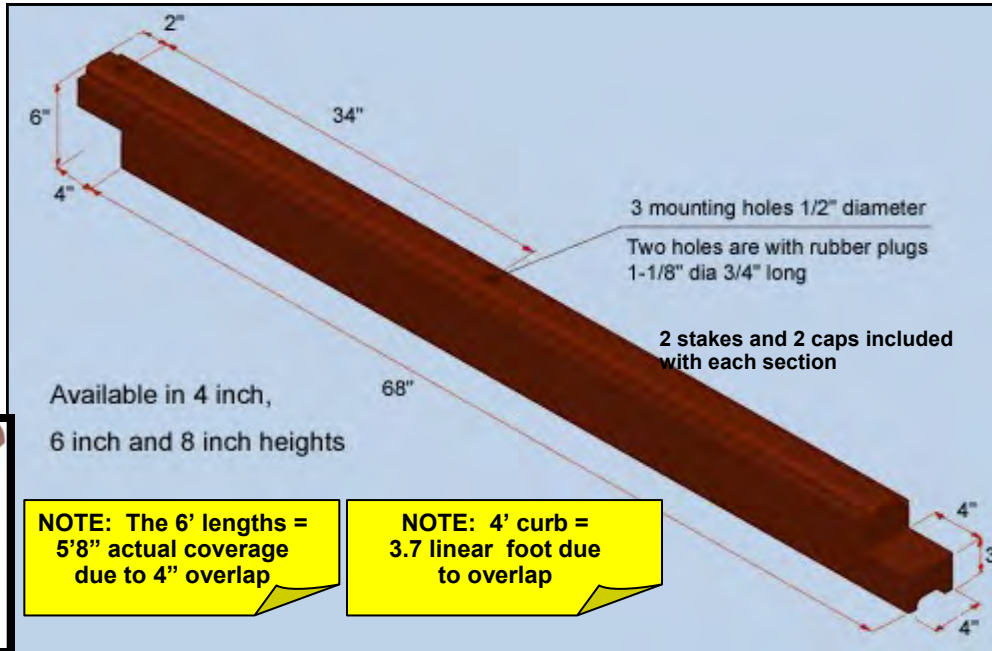

**NOTE: The 6' lengths = 5'8" actual coverage due to 4" overlap**

**NOTE: 4' curb = 3.7 linear foot due to overlap**



- More resilient than wood
- No warping or discoloring
- No splinters
- Non toxic
- Will not rot
- Stackable
- Interlocking
- Available in 4 ft lengths and 6 ft lengths and 4", 6" and 8" heights
- No CCA or other harmful chemicals
- Easy to install with pre drilled holes
- Made from 100% recycled tires
- Flexible with rounded edges
- Will not breed ticks, termites or other insects
- Maintenance free
- Hardware & Caps included
- Neutral brown tone-compatible with any surface color

2 stakes and 2 caps are included with each curb

natural brown    bendable    stackable    interlocking    hardware included

**YOUR "ONE-STOP" SOURCE FOR AMERICA'S BASEBALL, SOFTBALL & SPORTS SURFACES & SUPPLIES!**

PRICES SUBJECT TO CHANGE & AVAILABILITY PLUS SHIPPING | VOLUME DISCOUNTS AVAILABLE | COOPERATIVE PURCHASING CONTRACT PRICING FOR 50 STATES

**BEAM CLAY®**

Volleyball

## Rubber Curbing For Volleyball Courts

### Product Specifications

#### Product Description:

1. Material: compression molded composite of the 100% recycled rubber and polyurethane prepolymer
2. Physical properties of the rubber composite:
  - a) Density 0.6 oz/cu in (ASTM C642)
  - b) Durometer Hardness 65A  $\pm$  7 (ASTM D2240)
  - c) Tensile Strength\* minimum 125 psi (ASTM D412)  
(\* main structural areas)
  - d) Compression deformation 10% at 70psi, 68°F (ASTM D575)
  - e) Brittleness at Low temperature: -40°F (ASTM D746)
  - f) Freeze and thaw when exposed (ASTM C672)  
to deicing chemicals no loss after 50 cycles
  - g) Coefficient of thermal expansion: 8 x10<sup>-5</sup> in/in/°F (ASTM C531)
  - h) Weathering 70 hours at 158°F (ASTM D573)
    - hardness retained 100% ( $\pm$  5%)
    - compressive strength 100% ( $\pm$  5%)
    - tensile strength 100% ( $\pm$  5%)
    - elongation retained 100% ( $\pm$  5%)
3. Available models:
  - a) 4"W x 4"H x 72"L with weight of 30 lbs.
  - b) 4"W x 6"H x 72"L with weight of 45 lbs.
  - c) 4"W x 8"H x 72"L with weight of 70 lbs.
  - d) 3"W x 4"H x 72"L with weight of 20 lbs.
  - e) 3"W x 4"H x 48"L with weight of 13 lbs.
4. Finishing color: dark brown

#### Installation methods:

- a) with 2 spikes 18" long x 3/8" diameter provided for each 4" high piece
- b) with 2 spikes 24" long x 3/8" diameter provided for each 6" high or 8" high piece

Note: The mounting holes can be closed after installation with the rubber plugs 1-1/8 diameter and 3/4" long, supplied with the product.

#### Components:

- a) 100% recycled rubber from car and truck tires (NR, SBR)
- b) polyurethane prepolymer for rubber granules
- c) brown pigment

**YOUR "ONE-STOP" SOURCE FOR AMERICA'S BASEBALL, SOFTBALL & SPORTS SURFACES & SUPPLIES!**

PRICES SUBJECT TO CHANGE & AVAILABILITY PLUS SHIPPING | VOLUME DISCOUNTS AVAILABLE | COOPERATIVE PURCHASING CONTRACT PRICING FOR 50 STATES



# BEAM CLAY®

## WHOLESALE PRICE LIST EFFECTIVE: JULY 1, 2021

### Outdoor Volleyball System Packages



#### Coastal Competition Volleyball System

Heavy-duty system designed to withstand coastal winds and weather. Adjustable winches for play at any height!

- 4" square heavy-walled aluminum uprights with additional inside lateral support
- Ground sleeves, installation tool, winches, and weather resistant net included
- Uprights: 3 Year Limited Warranty, Net: 1 Year Limited Warranty
- Delivers via Common Carrier

#### OCC-500 System

Coastal Competition Volleyball System, 195 lbs

**\$1,503/SYS**

#### OCC-500N

Replacement Net, 9 lbs

**\$196/EA**

Inside lateral support



OCC-500N

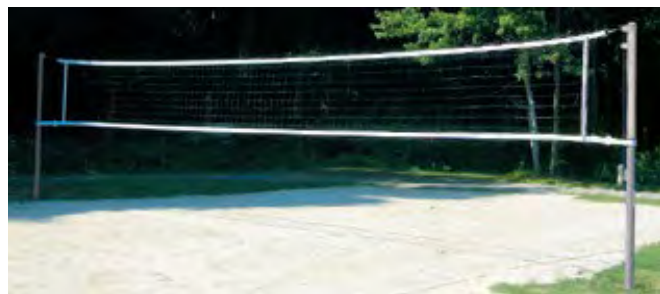

#### Outdoor Competition Volleyball System

Durable system designed for outdoor competition. Fixed net heights for men's and women's play!

- 3½" galvanized steel uprights with silver powder coat finish
- Quickly attach net with snap buckles
- Available in system and center package models
- 36" ground sleeves, cover caps, and rust-resistant ratchet included
- Net (PVBN-3 or PVBN-6J) sold separately
- 3 Year Limited Warranty
- Delivers via common carrier

**OCV-900** System, 140 lbs

**\$1,116/SYS**

**OCV-900C** Center Package, 125 lbs

**\$651/EA**



**AVCL-2**, 2 lbs

**\$57/EA**



#### Recreational Outdoor Volleyball System

Galvanized steel system ideal for volleyball, badminton, or tennis.

- 238" galvanized steel uprights
- PVC ground sleeves, top caps, and rust-resistant ratchet included
- Net (VBN-32, VBD-6 or VBD-3) sold separately
- 3 Year Limited Warranty
- Delivers via common carrier

*Ground sleeves are designed to be set even with playing surface. Contact us for special installation requirements.*

**OS-350**, 80 lbs

**\$632/SYS**

#### Adjustable Volleyball Court Line

- 2" wide black webbed boundary line
- Adjusts from 30' x 60' to FIVB regulation (8m x 16m)
- 8" corner stakes with bungee cord and plastic reel included
- Inside lateral support OCC-500N
- 3 Year Limited Warranty

**YOUR "ONE-STOP" SOURCE FOR AMERICA'S BASEBALL, SOFTBALL & SPORTS SURFACES & SUPPLIES!**

PRICES SUBJECT TO CHANGE & AVAILABILITY PLUS SHIPPING | VOLUME DISCOUNTS AVAILABLE | COOPERATIVE PURCHASING CONTRACT PRICING FOR 50 STATES

# BEAM CLAY®

Mercury Outdoor Volleyball Systems

**WHOLESALE PRICE LIST**  
 EFFECTIVE: JULY 1, 2021



See page 17 for the Beach Referee Stand

## Mercury™ Beach Volleyball Net

Adjustable beach systems with inverted telescoping design and carbon reinforced caps to prevent sand and water infiltration.

- NFHS, NCAA, USVBA, and FIVB compliant
- Adjustable height between 5'6" and 7'11.58"
- 3½" bottom poles compatible with any 3½" ID sleeves (OBV-100AK recommended and sold separately)
- Lightweight carbon or aluminum design
- Mercury™ net (competition or recreation size), antenna, and upright padding included
- 3 Year Limited Warranty
- Delivers via common carrier
- Specify upright padding color and preferred net when ordering.

### 3½" Aluminum

<b>OBV100-OFF</b> Complete System—including official net, 78 lbs	<b>\$2,822/EA</b>
<b>OBV100-REC</b> Complete System—including recreational net, 78 lbs	<b>\$2,822/EA</b>
<b>OBV100U</b> Uprights Only—including winch, 75 lbs	<b>\$2,022/PR</b>



Ground Insert

Top Cap

Quik-Collar



### Ground Inserts

- Inverted design keeps sand out
- Caps and safety flag included
- 3 Year Limited Warranty

**OBV-100AK**, 15 lbs **\$559/PR**



## Mercury™ Beach Volleyball Net

- 3" vinyl border and headband with 4" #36 black netting
- ¼" top Plateena cord with swaged loop on one end
- ¼" double braided polyester bottom rope
- Dowels and polyester straps with buckles included
- Custom headband (CVNT-1) and side net tapes (CVNT-2) sold separately
- 1 Year Limited Warranty
- Delivers via Common Carrier

<b>OBVN-1</b> Official Competition Net 28'L x 39"H, 12 lbs	<b>\$414/EA</b>
<b>OBVN-2</b> Recreational Size Net 32'L x 39"H, 12 lbs	<b>\$282/EA</b>

**YOUR "ONE-STOP" SOURCE FOR AMERICA'S BASEBALL, SOFTBALL & SPORTS SURFACES & SUPPLIES!**

PRICES SUBJECT TO CHANGE & AVAILABILITY PLUS SHIPPING | VOLUME DISCOUNTS AVAILABLE | COOPERATIVE PURCHASING CONTRACT PRICING FOR 50 STATES



# BEAM CLAY<sup>®</sup>

JAYPRO Volleyball System Packages

**WHOLESALE PRICE LIST**  
 EFFECTIVE: JULY 1, 2021



## POWERLite™ Volleyball System Package

- Powerlite™ Volleyball System (PVB-6500 or PVB-7000)
- Folding Referee Stand (VRS-6000)
- Referee Stand Padding (VRS-60P)
- Hammock Drill Cart (HSVBC24)
- Cable/Buckle Covers (VCC-12)
- Specify pad color when ordering.
- Ships Common Carrier
- Made in the USA

\* Uprights: 10 Year Limited Warranty, Net: 1 Year Limited Warranty, all other items: 3 Year Limited Warranty

**PVB-7PKG** 3½" System 240 lbs PKG **\$4,527**

**PVB-6PKG** 3" System 232 lbs PKG **\$4,527**



## POWERLite™

Deluxe Volleyball System Package

- Powerlite™ Volleyball System (PVB-6500 or PVB-7000)
- Folding Referee Stand (VRS-6000)
- Referee Stand Padding (VRS-60P)
- Hammock Drill Cart (HSVBC24)
- Cable/Buckle Covers (VCC-12)
- Standard Volleyball Equipment Carrier (EC-500)
- Custom Volleyball Net Tape (CVNT-1)
- Multi-Color Lettering and Logo (JSG-VPP)
- Specify pad color when ordering.
- Ships Common Carrier
- Made in the USA

\* Uprights: 10 Year Limited Warranty, Net: 1 Year Limited Warranty, all other items: 3 Year Limited Warranty

**PVB-7PKGDX** 3½" System 241 lbs PKG **\$4,766**

**PVB-6PKGDX** 3" System 294 lbs PKG **\$4,766**



**YOUR "ONE-STOP" SOURCE FOR AMERICA'S BASEBALL, SOFTBALL & SPORTS SURFACES & SUPPLIES!**

PRICES SUBJECT TO CHANGE & AVAILABILITY PLUS SHIPPING | VOLUME DISCOUNTS AVAILABLE | COOPERATIVE PURCHASING CONTRACT PRICING FOR 50 STATES



# BEAM CLAY®

JAYPRO Volleyball System Packages

**WHOLESALE PRICE LIST**  
 EFFECTIVE: JULY 1, 2021



## FEATHERLite™ Volleyball System Package

- Featherlite™ Volleyball System (PVB-4500 or PVB-5000)
- Folding Referee Stand (VRS-6000)
- Referee Stand Padding (VRS-60P)
- Hammock Drill Cart (HSVBC24)
- Cable/Buckle Covers (VCC-12)
- Specify pad color when ordering.
- Ships Common Carrier
- Made in the USA

\* Limited Warranties  
 \* Uprights: 10 Year Limited Warranty, Net: 1 Year Limited Warranty, all other items: 3 Year Limited Warranty

**PVB-5PKG** 3½" System, 227 lbs PKG **\$3,761**

**PVB-4PKG** 3" System, 231 lbs PKG **\$3,761**



## FEATHERLite™ Deluxe Volleyball System Package

- Featherlite™ Volleyball System (PVB-4500 or PVB-5000)
- Folding Referee Stand (VRS-6000)
- Referee Stand Padding (VRS-60P)
- Hammock Drill Cart (HSVBC24)
- Cable/Buckle Covers (VCC-12)
- Standard Volleyball Equipment Carrier (EC-500)
- Custom Volleyball Net Tape (CVNT-1)
- Multi-Color Lettering and Logo (JSG-VPP)
- Specify pad color when ordering.
- Ships Common Carrier
- Made in the USA

Uprights: 10 Year Limited Warranty, Net: 1 Year Limited Warranty, all other items: 3 Year Limited Warranty

**PVB-5PKGDX** 3½" System, 282 lbs PKG **\$4,050**

**PVB-4PKGDX** 3" System, 282 lbs PKG **\$4,050**



**YOUR "ONE-STOP" SOURCE FOR AMERICA'S BASEBALL, SOFTBALL & SPORTS SURFACES & SUPPLIES!**

PRICES SUBJECT TO CHANGE & AVAILABILITY PLUS SHIPPING | VOLUME DISCOUNTS AVAILABLE | COOPERATIVE PURCHASING CONTRACT PRICING FOR 50 STATES

# BEAM CLAY®

JAYPRO Volleyball Systems

**WHOLESALE PRICE LIST**  
EFFECTIVE: JULY 1, 2021

## Powerlite™ Volleyball Systems

Adjustable volleyball systems for international, collegiate, and advanced high school level play. NCAA, NFHS, and USVBA compliant!

- Aluminum uprights with engraved height markers
- Infinite height adjustment range from 6'6" to 8'2"
- Recessed polymer pulley wheels and worm winch
- Available in 3" and 3½" models
- Complete system, uprights only, and center packages
- 3" uprights include factory installed adapters
- Flex Net™ (PVBN-6), antennas, and upright padding included with complete system
- Specify pad color when ordering.
- Ships Common Carrier
- Made in the USA



	Weight	3"	Price	Weight	3½"	Price
Complete System	117 lbs	<b>PVB-6500</b>	<b>\$3,692</b>	131 lbs	<b>PVB-7000</b>	<b>\$3,692</b>
Uprights Only	89 lbs	<b>PVB-65U</b>	<b>\$2,737</b>	85 lbs	<b>PVB-70U</b>	<b>\$2,737</b>

*Includes winch. Net, antennas, and upright padding sold separately.*

Center Package	63 lbs	<b>PVBC-650</b>	<b>\$2,773</b>	62 lbs	<b>PVBC-700</b>	<b>\$2,773</b>
----------------	--------	-----------------	----------------	--------	-----------------	----------------

*Includes center pole, winch, Flex Net™, and upright padding. Purchase this in addition to complete system for a two court setup.*

*\*Uprights: 10 Year Limited Warranty, Padding & Antennas: 3 Year Limited Warranty, Net: 1 Year Limited Warranty*



## Complete System

Uprights with Winch



Flex Net™



Upright Padding



Antenna



## System Features

Infinite Height Adjustment



Recessed Pulley Wheel

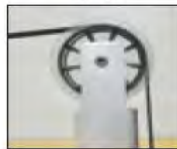

Worm Drive Winch



Engraved Height Markings



**YOUR "ONE-STOP" SOURCE FOR AMERICA'S BASEBALL, SOFTBALL & SPORTS SURFACES & SUPPLIES!**

PRICES SUBJECT TO CHANGE & AVAILABILITY PLUS SHIPPING | VOLUME DISCOUNTS AVAILABLE | COOPERATIVE PURCHASING CONTRACT PRICING FOR 50 STATES



# BEAM CLAY®

JAYPRO Volleyball Systems

**WHOLESALE PRICE LIST**  
EFFECTIVE: JULY 1, 2021



## Featherlite™ Volleyball Systems

Adjustable volleyball systems for collegiate and high school level play. NCAA, NFHS, and USVBA compliant!

- Aluminum uprights with engraved height markers
- 16 pin-stop height adjustment range from 6'6" to 8'2"
- Recessed polymer pulley wheels and worm winch
- Available in 3", 3½", and 2" (Canadian) models
- Complete system, uprights only, and center packages
- 3" uprights include factory installed adapters
- Flex Net™ (PVBN-6), antennas, and upright padding included with complete system
- Specify pad color when ordering.
- Ships Common Carrier
- Made in the USA

	Weight	3"	Price	Weight	3½"	Price
Complete System	115 lbs	<b>PVB-4500</b>	<b>\$3,009</b>	115 lbs	<b>PVB-5000</b>	<b>\$3,009</b>
Uprights Only	77 lbs	<b>PVB-45U</b>	<b>\$1,938</b>	73 lbs	<b>PVB-51U</b>	<b>\$1,903</b>
Center Package	56 lbs	<b>PVBC-450</b>	<b>\$2,087</b>	73 lbs	<b>PVBC-500</b>	<b>\$2,087</b>

*Includes winch, Net, antennas, and upright padding sold separately.*

*Includes center pole, winch, Flex Net™, and upright padding. Purchase this in addition to complete system for a two court setup.*

\* Uprights: 10 Year Limited Warranty, Padding & Antennas: 3 Year Limited Warranty, Net: 1 Year Limited Warranty



## Complete System



## System Features



**YOUR "ONE-STOP" SOURCE FOR AMERICA'S BASEBALL, SOFTBALL & SPORTS SURFACES & SUPPLIES!**

PRICES SUBJECT TO CHANGE & AVAILABILITY PLUS SHIPPING | VOLUME DISCOUNTS AVAILABLE | COOPERATIVE PURCHASING CONTRACT PRICING FOR 50 STATES



# BEAM CLAY®

## WHOLESALE PRICE LIST EFFECTIVE: July 1, 2021

### JAYPRO Volleyball & Badminton Systems



### Carbon Volleyball Systems

Significantly lightweight volleyball systems with the rigidity of steel. Fabricated from state-of-the-art carbon composite material!

- Adjustable feet with up to 3" of fine tuning
- Recessed polymer pulley wheels and worm drive winch
- Available in 3" and 3½" models
- Complete system, uprights only, and center packages
- Flex Net™ (PVBN-6), antennas, and upright padding included with complete system
- Specify pad color when ordering.
- Ships Common Carrier
- Made in the USA

### LadyPro Carbon

Carbon uprights are fixed women's height (7'4 1/8").

	Weight	3"	Price	Weight	3½"	Price
Complete System	77 lbs	<b>PVB-8500</b>	<b>\$4,766</b>	77 lbs	<b>PVB-8000</b>	<b>\$4,766</b>
Uprights Only	43 lbs	<b>PVB-85U</b>	<b>\$3,384</b>	43 lbs	<b>PVB-80U</b>	<b>\$3,384</b>

*Includes winch, Net, antennas, and upright padding sold separately*

Center Package	68 lbs	<b>PVBC-850</b>	<b>\$3,009</b>	58 lbs	<b>PVBC-800</b>	<b>\$3,009</b>
----------------	--------	-----------------	----------------	--------	-----------------	----------------

*Includes center pole, winch, Flex Net™, and upright padding. Purchase this in addition to complete system for a two court setup.*

Uprights, Padding and Antennas: 3 Year Limited Warranty, Net: 1 Year Limited Warranty

### Carbon Ultralite

Telescoping carbon uprights (intramurals to men's competition).

	Weight	3"	Price	Weight	3½"	Price
Complete System	81 lbs	<b>PVB-9500</b>	<b>\$5,017</b>	77 lbs	<b>PVB-9000</b>	<b>\$5,017</b>
Uprights Only	47 lbs	<b>PVB-95U</b>	<b>\$4,138</b>	43 lbs	<b>PVB-90U</b>	<b>\$4,138</b>

*Includes winch, Net, antennas, and upright padding sold separately.*

Center Package	68 lbs	<b>PVBC-950</b>	<b>\$3,134</b>	68 lbs	<b>PVBC-900</b>	<b>\$3,134</b>
----------------	--------	-----------------	----------------	--------	-----------------	----------------

*Includes center pole, winch, Flex Net™, and upright padding. Purchase this in addition to complete system for a two court setup.*

\* Uprights, Padding and Antennas: 3 Year Limited Warranty, Net: 1 Year Limited Warranty

### Competition Badminton System

Durable system designed for high school, intramural and recreational competition level play. Official height!

- 238" x 61" steel uprights with fixed net height
- Badminton net and floor sleeves/covers sold separately
- Made in the USA

Badminton System, PAIR	47 lbs	<b>BSO-2U</b>	<b>\$272</b>
Badminton Net, EACH	7 lbs	<b>BND-1</b>	<b>\$61</b>
Floor Sleeve & Brass Cover, PAIR	23 lbs	<b>BSO-2G</b>	<b>\$385</b>
Floor Sleeve & Chrome Cover, PAIR	23 lbs	<b>BSO-2G-CP</b>	<b>\$282</b>

\* System and Floor Sleeves: 3 Year Limited Warranty, Net: 1 Year Limited Warranty

See pages ??? for our  
Volleyball and Badminton related equipment



**YOUR "ONE-STOP" SOURCE FOR AMERICA'S BASEBALL, SOFTBALL & SPORTS SURFACES & SUPPLIES!**

PRICES SUBJECT TO CHANGE & AVAILABILITY PLUS SHIPPING | VOLUME DISCOUNTS AVAILABLE | COOPERATIVE PURCHASING CONTRACT PRICING FOR 50 STATES

# BEAM CLAY®

JAYPRO Volleyball Systems

**WHOLESALE PRICE LIST**  
EFFECTIVE: July 1, 2021



3" Classic Steel (PVB-3000)



3 1/2" Steel (PVB-1500)

## Hybrid Collegiate Net Systems

Designed for international, collegiate, and high school level play. Steel bottom for strength and aluminum top for lightness!

- Steel uprights with engraved height markers
- 16 pin-stop height adjustment range from 6'6" to 8'2"
- Recessed pulley wheels and worm drive winch
- Available in 3" (red) and 3 1/2" (black) models
- Complete system, uprights only, and center packages
- Flex Net™ (PVBN-6), antennas, and upright padding included with complete system
- Specify pad color when ordering
- Ships Common Carrier
- Made in the USA

	Weight	3"	Price	Weight	3 1/2"	Price
Complete System	177 lbs	<b>PVB-3000</b>	<b>\$2,534</b>	164 lbs	<b>PVB-1500</b>	<b>\$2,534</b>
Uprights Only	123 lbs	<b>PVB-30U</b>	<b>\$1,664</b>	118 lbs	<b>PVB-150U</b>	<b>\$1,664</b>

*Includes winch, Net, antennas, and upright padding sold separately.*

Center Package	93 lbs	<b>PVBC-300</b>	<b>\$1,664</b>	89 lbs	<b>PVBC-150</b>	<b>\$1,664</b>
----------------	--------	-----------------	----------------	--------	-----------------	----------------

*Includes center pole, winch, Flex Net™, and upright padding. Purchase this in addition to complete system for a two court setup.*

\* Uprights: 5 Year Limited Warranty, Padding and Antennas: 3 Year Limited Warranty, Net: 1 Year Limited Warranty



## Multi-Purpose Net System

Lightweight adjustable net system designed for high school, intramural, and recreational competition level play. Easily convert from competition volleyball to badminton or tennis!

- Anodized aluminum uprights with infinite height adjustment sliding collars
- Available in 3 1/2" and 2" (Canadian) models
- Complete system, uprights only, and center package
- Net, antennas, worm drive winch, and upright padding included with complete system
- Specify pad color when ordering
- Ships Common Carrier
- Made in the USA

	Weight	3 1/2"	Price
Complete System	128 lbs	<b>PVB-1350</b>	<b>\$2,311</b>
Uprights Only	83 lbs	<b>PVB-13U</b>	<b>\$1,597</b>

*Includes winch, Net, antennas, and upright padding sold separately.*

Center Package	62 lbs	<b>PVBC-130</b>	<b>\$1,489</b>
----------------	--------	-----------------	----------------

*Includes center pole, winch, Flex Net™, and upright padding. Purchase this in addition to complete system for a two court setup.*

Canadian Size	Weight	2"	Price
Complete System	118 lbs	<b>PVB-1250</b>	<b>\$2,377</b>
Uprights Only	80 lbs	<b>PVB-12U</b>	<b>\$1,717</b>

Includes winch.

\* Uprights: 10 Year Limited Warranty, Padding & Antennas: 3 Year Limited Warranty, Net: 1 Year Limited Warranty

**YOUR "ONE-STOP" SOURCE FOR AMERICA'S BASEBALL, SOFTBALL & SPORTS SURFACES & SUPPLIES!**

PRICES SUBJECT TO CHANGE & AVAILABILITY PLUS SHIPPING | VOLUME DISCOUNTS AVAILABLE | COOPERATIVE PURCHASING CONTRACT PRICING FOR 50 STATES

# BEAM CLAY®

## WHOLESALE PRICE LIST EFFECTIVE: July 1, 2021

JAYPRO Volleyball Systems, Base Pads, Antennas & Boundary Tape

### Second Floor Competition Net Systems

Adjustable systems designed for collegiate and high school level play. For use where floor sleeves are impractical. Top level performance without cables or wires. NCAA, NFHS, and USVBA compliant!

- 3½" aluminum uprights
- Infinite height adjustment and pin-stop height adjustment models
- 16 pin-stop height adjustment model has range from 6'6" to 8'2"
- Hand knobs secure steel T-base to in-floor anchors (sold separately)
- Complete system, uprights only, and center packages
- Flex Net™ (PVBN-6), upright/base padding, antennas, and worm drive winch included
- Specify pad color when ordering.
- Ships Common Carrier
- Made in the USA

	Weight	Infinite	Price	Weight	Pin Stop	Price
Complete System	208 lbs	<b>PVB-2700</b>	<b>\$4,066</b>	192 lbs	<b>PVB-2500</b>	<b>\$3,533</b>
Uprights Only	155 lbs	<b>PVB-270UB</b>	<b>\$3,199</b>	145 lbs	<b>PVB-250UB</b>	<b>\$2,162</b>
Includes winch, Net, antennas, and upright padding sold separately.						
Center Package	114 lbs	<b>PVBC-270</b>	<b>\$3,327</b>	109 lbs	<b>PVBC-250</b>	<b>\$2,312</b>
Includes center pole, winch, Flex Net™, and upright padding. Purchase this in addition to complete system for a two court setup.						

\* Uprights, Antennas and Padding: 3 Year Limited Warranty, Net: 1 Year Limited Warranty



#### Replacement Base Pad

- Standard base pad designed for
- Second Floor Competition Net Systems (PVB-2700 and PVB-2500).
- Specify base pad color when ordering.
- Made in the USA
- 3 Year Limited Warranty

**PVB-25P**    11 lbs    **\$357 PR**



#### Cable/Buckle Cover

- 12" long white vinyl covered foam
- Hook-and-loop attachment
- Made in the USA
- 3 Year Limited Warranty

**VCC-12**    4 lbs    **\$71 PR**



#### Universal Antennas

- 72" long alternating red/white stripes
- Clamp directly to top and bottom of net
- Fits 36" and 39" nets
- 3 Year Limited Warranty

**VBA-80**    2 lbs    **\$143 PR**



#### Antennas

- Slides into hook-and-loop attached sleeves
- Fits 36" and 39" nets
- 3 Year Limited Warranty

**VBA-4**    4 lbs    **\$136 PR**

#### Boundary Tape

- 2" tape with hook-and-loop closure
- Fits 36" and 39" nets
- 3 Year Limited Warranty

**VA-22**    1 lbs    **\$28 PR**



**YOUR "ONE-STOP" SOURCE FOR AMERICA'S BASEBALL, SOFTBALL & SPORTS SURFACES & SUPPLIES!**

PRICES SUBJECT TO CHANGE & AVAILABILITY PLUS SHIPPING | VOLUME DISCOUNTS AVAILABLE | COOPERATIVE PURCHASING CONTRACT PRICING FOR 50 STATES



# BEAM CLAY®

Volleyball Nets

WHOLESALE PRICE LIST  
EFFECTIVE: JULY 1, 2021



## Flex Net™

Heavy-duty nylon banded net eliminates use of cumbersome cables.  
Designed for international, collegiate, and high school competition play!

- For uprights set between 35' and 37'
- Headband attaches directly to winch leader strap for superb net tension
- Adjustable straps attach to existing bottom band for additional length (not included with all nets)
- 1 Year Limited Warranty

*Due to varying court sizes, the net body may not match all court widths.*



Item #	set between	Net Size	Included	Weight	Price
--------	-------------	----------	----------	--------	-------

### Flex Net™

<b>PVBN-6</b>	35' - 37'	32'L x 39"H	No	14 lbs	<b>\$ 514 EA</b>
---------------	-----------	-------------	----	--------	------------------

## Flex Net™ (with Adapter Cord)

- Adapter cord connects existing winch and anchor upright to top of Flex Net™
- ¼" dia. anchor cord and clips included
- 1 Year Limited Warranty

*Compatible with most manufacturer's systems such as Porter, Senoh, Bison, MacGregor, Stackhouse, Schelde, or other similar volleyball systems. Anchor cord should be cut to length in the field to adapt to the specific volleyball system.*

## Flex Net™ (with Adapter Strap)

- 2" wide adapter strap bridges anchor upright to top of Flex Net™
- 1 Year Limited Warranty

*Compatible with Schelde or other similar volleyball systems.*

<b>PVBN-6J</b>	13 lbs	<b>\$576 EA</b>
----------------	--------	-----------------

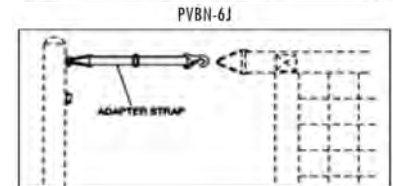
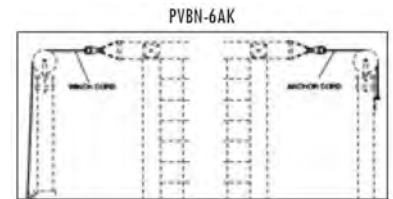

<b>PVBN-6AK</b>	14 lbs	<b>\$576 EA</b>
-----------------	--------	-----------------

## PREMIERE COMPETITION NET

Collegiate and High School use.

- 3.5mm knotless poly net
- Plateena top cord
- 32'L x 39"H
- 1 Year Limited Warranty



<b>PVBN-5</b>	<b>\$306 EA</b>
---------------	-----------------

## COMPETITION NET

High School and Recreational use.

- #21 nylon net
- Coated steel cable
- 32'L x 39"H
- 1 Year Limited Warranty



<b>PVBN-3</b>	<b>\$240 EA</b>
---------------	-----------------

## VOLLEYBALL NET

Recreational use.

- 2.5 mm Nylon net
- Rope cable
- 32'L x 36"H
- 1 Year Limited Warranty



<b>VBN-32</b>	<b>\$93 EA</b>
---------------	----------------

## VOLLEYBALL NET

Recreational use.

- 2.5mm poly net
- Coated steel cable
- 32'L x 36"H
- 1 Year Limited Warranty

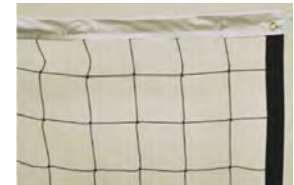

<b>VBD-3</b>	<b>\$86 EA</b>
--------------	----------------

**YOUR "ONE-STOP" SOURCE FOR AMERICA'S BASEBALL, SOFTBALL & SPORTS SURFACES & SUPPLIES!**

PRICES SUBJECT TO CHANGE & AVAILABILITY PLUS SHIPPING | VOLUME DISCOUNTS AVAILABLE | COOPERATIVE PURCHASING CONTRACT PRICING FOR 50 STATES

# BEAM CLAY®

**WHOLESALE PRICE LIST**  
 EFFECTIVE: JULY 1, 2021

Volleyball Net Keepers / Custom Net Tape



### Single Net Keeper

- 1½" thick-walled steel design
- Powder coat finish
- Headband is wound clean and tangle free
- Non-marking swivel wheels
- 1 storage bag included
- 3 Year Limited Warranty

**VNK11**    28 lbs    **\$235 EA**



### Double Net Keeper

- 1½" thick-walled steel design
- Powder coat finish
- Headband is wound clean and tangle free
- Non-marking swivel wheels
- 2 storage bags included
- 3 Year Limited Warranty

**VNK22**    33 lbs    **\$274 EA**



### Triple Net Keeper

- 1½" thick-walled steel design
- Powder coat finish
- Headband is wound clean and tangle free
- Non-marking swivel wheels
- 3 storage bags included
- 3 Year Limited Warranty

**VNK33**    37 lbs    **\$314 EA**

### Net Keeper Storage Bag

Replacement storage bag keeps nets, cords, and cables off the floor and protected.  
 • 1 Year Limited Warranty

**VNKBAG**    1 lbs    **\$35 EA**

### Custom Volleyball Net Tape

Customize volleyball nets with a multi-color school logo and team name. Fits most net sizes. Contact customer service for artwork requirements. Extended lead time may apply.  
 • 1 Year Limited Warranty

**CVNT-1** Top Net Tape EA    3 lbs    **\$292 EA**

**CVNT-2** Side Net Tape PR    2 lbs    **\$160 PR**



**YOUR "ONE-STOP" SOURCE FOR AMERICA'S BASEBALL, SOFTBALL & SPORTS SURFACES & SUPPLIES!**

PRICES SUBJECT TO CHANGE & AVAILABILITY PLUS SHIPPING | VOLUME DISCOUNTS AVAILABLE | COOPERATIVE PURCHASING CONTRACT PRICING FOR 50 STATES

# BEAM CLAY®

## WHOLESALE PRICE LIST EFFECTIVE: JULY 1, 2021

### Volleyball Referee Stands



Shown with optional padding

#### “MEGA REF” Folding Referee Stand

Durable referee stand with all welded frame support and no-slip foot treads. Fold for compact storage and easy transport!

- 158” heavy-walled steel design
- Vinyl padded platform (48” above floor)
- 4 non-marking wheels and rubber leg tips included
- Optional padding (VRS-60P) sold separately
- Folds Down - 30”W x 84”H x 10”D
- **300 lbs. maximum user weight.**
- 3 Year Limited Warranty

**VRS-8000**    78 lbs    **\$935 EA**

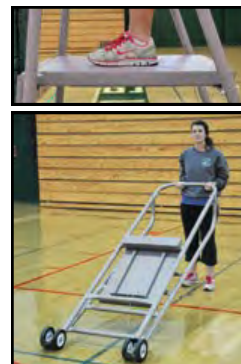

Shown with optional padding

#### Folding Referee Stand

Durable referee stand folds for compact storage and easy transport.

- 1516” strong steel design
- Vinyl padded platform (48” above floor)
- 2 non-marking wheels and rubber leg tips included
- Optional padding (VRS-60P) sold separately
- Folds Down - 30”W x 84”H x 10”D
- **250 lbs. maximum user weight.**
- 3 Year Limited Warranty

**VRS-6000**    62 lbs    **\$650 EA**

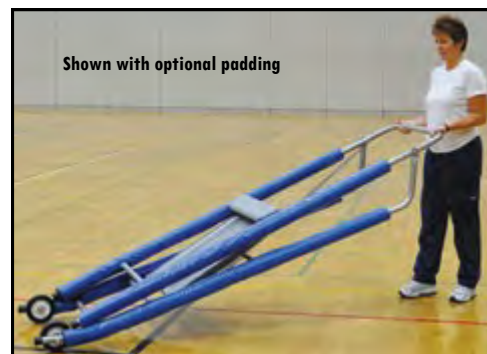

Shown with optional padding



Shown with optional padding

#### Adjustable Referee Stand

Durable two leg design referee stand clamps onto most telescoping pole systems. Adjustable feet for tweaking height!

- 1516” strong steel design with vinyl padded platform
- 2 non-marking wheels and rubber leg tips included
- Optional padding (VRS-30P) sold separately
- 3 Year Limited Warranty, 225 lbs. maximum user weight
- *Does not fit Multi-Purpose Net System (PVB-1350) or Outdoor Competition Volleyball System (OCV-900).*

**VRS-3000**    55 lbs    **\$735 EA**

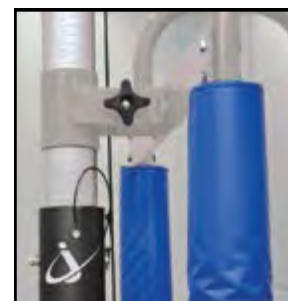

Stand clamps to volleyball pole



Shown with optional side banners

#### Beach Volleyball Referee Stand

Durable steel referee stand with all welded frame support and no-slip foot treads. Front base plate prevents stand from sinking. Transports across sand easily!

- 158” heavy-walled design with silver textured powder coat finish
- Padded platform (48” above sand)
- 2 heavy-duty 10” dia. x 3½”W molded wheels
- Optional padding (VRS-60P) and custom side banners (CVNT-3) sold separately
- Folds Down - 30”W x 84”H x 10”D
- **260 lbs. maximum user weight.**
- 3 Year Limited Warranty
- Made in the USA

**OBVRS-8** Stand    98 lbs    **\$1,215 EA**

**CVNT-3** Custom Side Banners    6 lbs    **\$285 PR**

**YOUR “ONE-STOP” SOURCE FOR AMERICA’S BASEBALL, SOFTBALL & SPORTS SURFACES & SUPPLIES!**

PRICES SUBJECT TO CHANGE & AVAILABILITY PLUS SHIPPING | VOLUME DISCOUNTS AVAILABLE | COOPERATIVE PURCHASING CONTRACT PRICING FOR 50 STATES



# BEAM CLAY®

WHOLESALE PRICE LIST  
EFFECTIVE: JULY 1, 2021

Volleyball Pads & Equipment Carriers



### Official Upright Pads

- Meets competitive play specifications
- 6'H x 2" thick foam wrapped in 14 oz. vinyl
- Hook-and-loop closure flaps
- Custom lettering and graphics sold separately
- Specify pad color when ordering.

**PVB-60P** 20 lbs **\$565 PR**



### Referee Stand Padding

- Meets competitive play specifications
- 1" thick foam wrapped in 14 oz. vinyl
- Specify pad color when ordering.

**VRS-60P** 9 lbs **\$330 EA**

### Custom Graphics for Upright Pads

Customize upright pads with single or multi-color lettering and graphics.



**JSG-VPP** **\$246PAD**

Multi-color custom lettering with graphic

Contact customer service for artwork requirements and pricing.



### Volleyball Equipment Carrier

Heavy-duty welded steel carrier stores volleyballs, uprights, nets, pads, and other equipment. Protective powder coat finish!

- Non-marking swivel wheels
- Standard, deluxe, and vertical models
- Deluxe and vertical models include vinyl storage bag

<b>EC-500</b>	42"L x 32"W - (4 poles)	38 lbs	<b>\$375EA</b>
<b>EC-1000</b>	48"L x 36"W - (6 poles)	79 lbs	<b>\$501 EA</b>
<b>VEC-1</b>	60"L x 35"W - (6 poles)	98 lbs	<b>\$476 EA</b>

**YOUR "ONE-STOP" SOURCE FOR AMERICA'S BASEBALL, SOFTBALL & SPORTS SURFACES & SUPPLIES!**

PRICES SUBJECT TO CHANGE & AVAILABILITY PLUS SHIPPING | VOLUME DISCOUNTS AVAILABLE | COOPERATIVE PURCHASING CONTRACT PRICING FOR 50 STATES

# BEAM CLAY®

Volleyball Floor Sleeves

**WHOLESALE PRICE LIST**  
 EFFECTIVE: JULY 1, 2021



## Floor Sleeves and Covers

- Lockable hinged cover
- Heavy-duty cast brass or chrome finish design
- Lockable hinged cover
- 7½" or 8½" outside dia. lockable hinged cover plates
- Spring loaded covers prevent basketball dead spots
- Available in 3½", 3", and 238" models (10" deep)
- 3 Year Limited Warranty

*Floor sleeves are generally 3", 3½", or 4". Jaypro Sports uprights are 3" or 3½". To ensure proper fit, measure existing floor sleeves prior to selecting system. See below for measuring instructions. Select the appropriate adapter that fits the measurements and system of choice.*



## Sleeves & Cover Plates

<b>PVB-75S</b>	Brass Sleeve & Cover 3½"	14 lbs	<b>\$371 PR</b>
<b>PVB-75S-CP</b>	Chrome Sleeve & Cover 3½"	15 lbs	<b>\$408 PR</b>
<b>PVB-70S</b>	Brass Sleeve & Cover 3"	22 lbs	<b>\$371 PR</b>
<b>PVB-70S-CP</b>	Chrome Sleeve & Cover 3"	22 lbs	<b>\$408 PR</b>
<b>BSO-2G</b>	Brass Sleeve & Cover 238"	23 lbs	<b>\$385 PR</b>
<b>BSO-2G-CP</b>	Chrome Sleeve & Cover 238"	23 lbs	<b>\$282 PR</b>

## Cover Plates

<b>PVB-711</b>	Brass Cover 7½"	6 lbs	<b>\$226 EA</b>
<b>PVB-75CVR-CP</b>	Chrome Cover 7½"	7 lbs	<b>\$243 EA</b>
<b>PVB-85CVR</b>	Brass Cover 8½"	7 lbs	<b>\$243 EA</b>

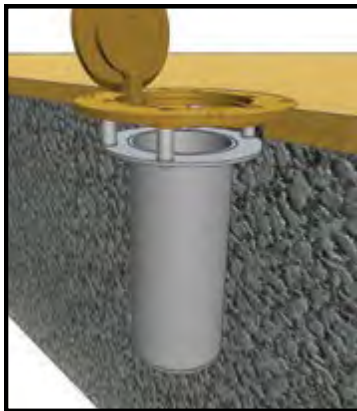

## Sleeve Insert Measurement

To ensure proper fit of sleeve inserts, provide the following dimensions of sleeves when ordering.

1. Depth of sleeve itself
2. Depth from bottom of sleeve to playing surface
3. Inside diameter of sleeve (do not measure cover plate)

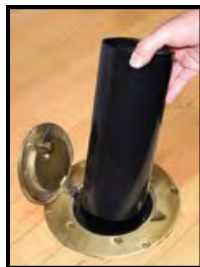
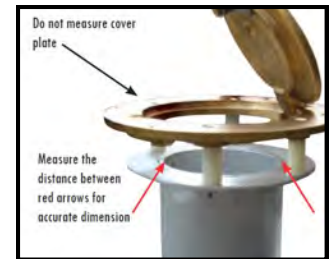

## Sleeve Insert/Adapter

- Makes larger floor sleeve holes smaller
- 3 Year Limited Warranty
- Made in the USA

Depths other than standard 9½" are special order items (non-returnable). Custom sizes (depths) may require longer lead time. Specify current depth and inside diameter when ordering.

<b>PVB-DEP</b>	Sleeve Insert	6 lbs	<b>\$92 EA</b>
<b>SVL-3238</b>	Modifies 3" ID to 238" ID	12 lbs	<b>\$82 EA</b>
<b>PVB-ID</b>	Modifies 3½" ID to 3" ID	8 lbs	<b>\$82 EA</b>
<b>SVL-3528</b>	Modifies 3½" ID to 238" ID	14 lbs	<b>\$88 EA</b>
<b>SVL-37835</b>	Modifies 3-7/8" ID to 3½" ID	9lbs	<b>\$45 EA</b>
<b>SVL-4035</b>	Modifies 4" ID to 3½" ID	9lbs	<b>\$74 EA</b>

**YOUR "ONE-STOP" SOURCE FOR AMERICA'S BASEBALL, SOFTBALL & SPORTS SURFACES & SUPPLIES!**

PRICES SUBJECT TO CHANGE & AVAILABILITY PLUS SHIPPING | VOLUME DISCOUNTS AVAILABLE | COOPERATIVE PURCHASING CONTRACT PRICING FOR 50 STATES

# BEAM CLAY®

## WHOLESALE PRICE LIST EFFECTIVE: JULY 1, 2021

### Volleyball Floor Anchors & Wall Rack



#### Floor Anchor (1 1/4" Cylinder)

For systems with "T" style or round bases that anchor to floor.

- 3/4" chrome cover with 1 1/4" wide cylinder
- Billet steel body gives 9000 lb. pullout strength
- 1/2" center - 13 thread with spring loaded closure plug
- Includes removable cylinder in case stripping occurs
- 3 Year Limited Warranty

*Designed for all floor applications except floating wood floors. May be used without extension bolt on wood, tile, or synthetic surfaces applied directly over concrete slab or on a floating wood floor for light-duty performance.*

**FP-89**      3 lbs      **\$136 EA**



#### Floor Anchor (1 1/4" Cylinder)

For systems with "T" style or round bases that anchor to floor.

- 1/4" wide cylinder
- Billet steel body gives 9000 lb. pullout strength
- 1/2" center - 13 thread with spring loaded closure plug
- Includes removable cylinder in case stripping occurs
- 3 Year Limited Warranty

*Designed for all floor applications except floating wood floors. May be used without extension bolt on wood, tile, or synthetic surfaces applied directly over concrete slab or on a floating wood floor for light-duty performance.*

**FP-90**      3 lbs      **\$119 EA**



#### Floating Wood Floor Anchor (1 1/4" Cylinder)

Brass cover plate and anchor work independently to allow for installation into floating wood floors.

- 3/4" brass cover with 1 1/4" wide cylinder
- Billet steel body gives 9000 lb. pullout strength
- 1/2" center - 13 thread with spring loaded closure plug
- Includes removable cylinder in case stripping occurs
- 3 Year Limited Warranty

**FP-100**      4 lbs      **\$146 EA**



#### Second Floor Sleeve Bracket

Designed for second story installation of floor sleeves or where there is less than 12" clearance in the sub-floor. Mounting hardware included.

- 3 Year Limited Warranty

**SB-10**      32 lbs      **\$300 EA**



#### Wall Rack

- Holds 3 volleyball posts in upright position
- Heavy-duty steel storage rack attaches to wall

**VBWR-1**      7 lbs      **\$187 EA**

**YOUR "ONE-STOP" SOURCE FOR AMERICA'S BASEBALL, SOFTBALL & SPORTS SURFACES & SUPPLIES!**

PRICES SUBJECT TO CHANGE & AVAILABILITY PLUS SHIPPING | VOLUME DISCOUNTS AVAILABLE | COOPERATIVE PURCHASING CONTRACT PRICING FOR 50 STATES



# BEAM CLAY®

**WHOLESALE PRICE LIST**  
EFFECTIVE: JULY 1, 2021

Volleyball Ball Carts, Carriers and System Replacement Parts



## Hammock Drill Cart

Durable steel frame is collapsible for easy storage with a low profile making it easier to turn, reach and spike.

- Holds up to 24 balls
- Nylon carry bag with shoulder strap included
- 48"L x 22"W x 40"H x 12"D
- 3 Year Limited Warranty

**HSVBC24** 15 lbs **\$151 EA**

## ToteMaster™ Open Top

- Holds up to 33 volleyballs, nets, pads, and other equipment
- 4" x 3" wire mesh open top storage baskets
- Deeper upper basket for larger items
- 48"L x 26"W x 54"H
- 3 Year Limited Warranty

**TE-PE01** 46 lbs **\$275 EA**



## Deluxe Ball Carriers

- Highly durable carriers with non-marking swivel wheels.
- 1" all welded steel frame
  - 12 Ball Carrier - 39"L x 22"W x 36"H
  - 18 Ball Carrier - 60"L x 22"W x 36"H
  - 5 Year Limited Warranty

### 12 Ball Carrier

<b>BBC-12RB</b>	Royal Blue	26 lbs	<b>\$110 EA</b>
<b>BBC-12BK</b>	Black	26 lbs	<b>\$110 EA</b>
<b>BBC-12RD</b>	Red	26 lbs	<b>\$110 EA</b>

### 18 Ball Carrier

<b>BBC-18RB</b>	Royal Blue	41 lbs	<b>\$145 EA</b>
<b>BBC-18BK</b>	Black	41 lbs	<b>\$145 EA</b>
<b>BBC-18RD</b>	Red	41 lbs	<b>\$145 EA</b>

## System Replacement Parts

- 3 Year Limited Warranty

### Worm Drive Winch

- 1½" Leader strap & handle included

**PVBWINCH** 7 lbs **\$364 EA**

### Cargo Buckle Winch

**HM5044** 3 lbs **\$81 EA**

### Leader Strap (for HM5044)

**PVB101A** 2 lbs **\$57 EA**

### Leader Strap (for PVBWINCH)

**PVB603** 1½" wide 3 lbs **\$67 EA**

### Winch Handle (for PVBWINCH purchased after 2008)

**VBW-HANDLE-08** 1 lb **\$68 EA**

### Handle

- For telescoping height adjustment and old blue style winch

**PVB6071** 1 lb **\$63 EA**

### Pin Chain Assembly (1500/5000/4500)

**PVB512** 2 lbs **\$17 EA**



PVBWINCH

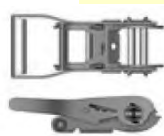

HM5044



PVB101A



PVB603



VBW-HANDLE-08



PVB6071



PVB512

**YOUR "ONE-STOP" SOURCE FOR AMERICA'S BASEBALL, SOFTBALL & SPORTS SURFACES & SUPPLIES!**

PRICES SUBJECT TO CHANGE & AVAILABILITY PLUS SHIPPING | VOLUME DISCOUNTS AVAILABLE | COOPERATIVE PURCHASING CONTRACT PRICING FOR 50 STATES

**BEAM CLAY®**

Volleyball Training Equipment

**WHOLESALE PRICE LIST**  
EFFECTIVE: JULY 1, 2021**The Blocker**

Practice defending blocked spikes.

- Adjustable aluminum pole (up to 11')
- 2' x 3' foam blocking surface
- Polyethylene base included
- 3 Year Limited Warranty

**TB11**, 7 lbs**\$275/EA****YOUR "ONE-STOP" SOURCE FOR AMERICA'S BASEBALL, SOFTBALL & SPORTS SURFACES & SUPPLIES!**

PRICES SUBJECT TO CHANGE &amp; AVAILABILITY PLUS SHIPPING | VOLUME DISCOUNTS AVAILABLE | COOPERATIVE PURCHASING CONTRACT PRICING FOR 50 STATES

**PARTAC PEAT CORPORATION**  
ONE KELSEY PARK, GREAT MEADOWS, NEW JERSEY 07838800-247-BEAM (2326) • (908) 637-4191 • FAX (908) 637-8421  
www.beamclay.com • sales@beamclay.com  
Bid Term - 5/9/18 - 5/8/20; Extended to 5/8/21; Extended to 5/8/22

# BEAM CLAY®

## WHOLESALE PRICE LIST EFFECTIVE: APRIL 23, 2021

Grooming Tools: Rakes, Loop Hoe Edger, Sand Comb, Sifting Scoop



### Double Play Sand Rake

- High-grade aluminum head and bracing
- 66" powder coated aluminum handle with 5" no-slip vinyl grip
- 1 Year Limited Warranty

**12524** 24" Blade, 5 lbs

**12536** 36" Blade, 5 lbs

**\$67.95/EA**

**\$79.95/EA**

### Sand Rake

- 66" lightweight aluminum/magnesium alloy head construction
- Straight, rounded cleaning teeth with extended straight edge specifically designed for grading and leveling.
- 1 Year Limited Warranty

**12024** 24" Blade, 5 lbs.

**12030** 30" Blade, 5 lbs.

**12036** 36" Blade, 6 lbs.

**12042** 42" Blade, 6 lbs.

**12048** 48" Blade, 6 lbs.

**\$64.95**

**\$68.95**

**\$70.95**

**\$77.95**

**\$82.95**



### LOOP HOE EDGER

- Double knife edge rocks back and forth with a push/pull motion
- Excellent for cultivating, aerating and weeding
- Replaceable blade
- 60" powder-coated aluminum handle
- 6" non-slip vinyl grip

**42100**, 5 lbs

**\$37.95/EA**



### SIFTING SCOOP

- Perfect tool for cleaning rocks, glass and unwanted debris from sand
- Lightweight one piece molded construction
- 42" long handle with 14" x 17" perforated scoop head

**49510**, 5 lbs

**\$115.95/EA**

**YOUR "ONE-STOP" SOURCE FOR AMERICA'S BASEBALL, SOFTBALL & SPORTS SURFACES & SUPPLIES!**

PRICES SUBJECT TO CHANGE & AVAILABILITY PLUS SHIPPING | VOLUME DISCOUNTS AVAILABLE | COOPERATIVE PURCHASING CONTRACT PRICING FOR 50 STATES



**BEAM CLAY®**

Champro Volleyballs

**WHOLESALE PRICE LIST**  
EFFECTIVE: JULY 1, 2021**ST-4000 PREMIER MICROFIBER VOLLEYBALL****VBST4000****\$29.95/EA**

The VB-ST4000 features our newest Pro-Lite premier lightweight microfiber cover construction that is ready for all levels of play. The microfiber cover allows for the softest touch feel with sting-free technology.

- Ideal for high school and college games
- Microfiber cover
- Floating butyl bladder
- NFHS approved

**ST-2500 VOLLEYBALL****VBST2500****\$21.95/EA**

- Ideal for indoor high school and youth games
- TechSoft laminated microfiber PU 1.6mm
- 2N1P winding
- Floating butyl bladder

A service charge of \$7.50 shall be added to all orders of less than \$100. #CHSC

**YOUR "ONE-STOP" SOURCE FOR AMERICA'S BASEBALL, SOFTBALL & SPORTS SURFACES & SUPPLIES!**

PRICES SUBJECT TO CHANGE & AVAILABILITY PLUS SHIPPING | VOLUME DISCOUNTS AVAILABLE | COOPERATIVE PURCHASING CONTRACT PRICING FOR 50 STATES

**PARTAC PEAT CORPORATION**  
ONE KELSEY PARK, GREAT MEADOWS, NEW JERSEY 07838

800-247-BEAM (2326) • (908) 637-4191 • FAX (908) 637-8421  
www.beamclay.com • sales@beamclay.com  
Bid Term - 5/9/18 - 5/8/20; Extended to 5/8/21; Extended to 5/8/22

# BEAM CLAY®

Champro Volleyballs

**WHOLESALE PRICE LIST**  
EFFECTIVE: JULY 1, 2021



## ST-700 PRO PERFORM VOLLEYBALL

**VB-ST700**

**\$13.95/EA**

The soft touch performance cover of the VB-ST700 features a PU leather cover over a butyl bladder for better performance and durability while on a budget for all ages. Indoor use only

Ideal for indoor high school practice and youth games

Soft Touch Performance PU leather cover

Butyl bladder

Color options:

White / black  
Scarlet / White / Royal

## VB-LITE TRAINING SERIES FEATHERLITE VOLLEYBALL

**VBL2**

**\$14.95/EA**

Ideal for younger players that want to improve their skills. The lightweight design is ideal for training, and the TechSoft composite cover offers high performance and a sting-free ball.

Ideal for youth training

Composite leather cover

Floating butyl bladder

8 oz. weight



## ST-300 COMPETITION RUBBER VOLLEYBALL

**VB41**

**\$9.95/EA**

Smooth and tough best describe the VB41. The waterproof rubber cover gives the volleyball a smooth feel, while the yarn winding makes it tough enough for indoor or outdoor play.

Ideal for indoor and outdoor practice

Tough waterproof rubber cover

100% butyl bladder with balanced nylon winding



## ST200 PRO PERFORMANCE VOLLEYBALL

**VB-ST200**

**\$12.25/EA**

The ST200 raises the bar on its VB59 predecessor on the grass, in the sand or indoors. The ST200's enhanced performance and responsiveness with its machine sewn performance touch cover. The team color combinations and digi camo options make this ball a winner on any court.

Ideal for outdoor games in all conditions

PVC cover

Butyl bladder

Color options:

Black, Camo Black, Camo Col. Blue, Camo Optic Orange, Camo Optic Pink, Camo Optic Yellow, Camo Scarlet, Forest Green, Gold, Navy, Orange, Royal, Scarlet



A service charge of \$7.50 shall be added to all orders of less than \$100. #CHSC

**YOUR "ONE-STOP" SOURCE FOR AMERICA'S BASEBALL, SOFTBALL & SPORTS SURFACES & SUPPLIES!**

PRICES SUBJECT TO CHANGE & AVAILABILITY PLUS SHIPPING | VOLUME DISCOUNTS AVAILABLE | COOPERATIVE PURCHASING CONTRACT PRICING FOR 50 STATES

# BEAM CLAY®

Dri-Ball Drying Agent

WHOLESALE PRICE LIST: F.O.B. GREAT MEADOWS, NJ  
 EFFECTIVE: JANUARY 1, 2021

**DRI-BALL®** Within 30 seconds turn any water-soaked ball into a perfectly dry ball! **DRI-BALL®** is quick and easy to use for games and practice! For baseball, softball, football, soccer, tennis, volleyball or any other sport with a ball that gets damp, wet or even soaking wet!

- Simply place the ball into an air-tight container with the **DRI-BALL®** compound.
- Shake the container - 30 seconds later, remove your ball and it will be completely dry and ready to use, and without any residue.
- **DRI-BALL®** also extends the life of balls, which reduces replacement costs.

One **DRI-BALL** kit contains 2 (1¼ lb.) packages of the **DRI-BALL** compound.

One to two kits should last one season, including practices:

#DB-KIT

\$75/Kit

- For baseball after wet practices, place 8-10 balls in 3-gallon container with 1 package of **DRI-BALL**. Shake for 30 seconds. All of the balls will be dry, will not rot, and will not get heavy. The entire kit should last for a 25-game season if you use **DRI-BALL** 2 to 3 days per week and keep **DRI-BALL** containers air-tight at all times.
- For football & soccer, dunk muddy balls into water to wash off mud. Place in 5-gallon container with 1 package of **DRI-BALL** and shake for 30 seconds. Your ball will be clean and dry! Nothing else is this easy! Keep **DRI-BALL** air-tight at all times.



**YOUR "ONE-STOP" SOURCE FOR AMERICA'S BASEBALL, SOFTBALL & SPORTS SURFACES & SUPPLIES!**

PRICES SUBJECT TO CHANGE & AVAILABILITY PLUS SHIPPING | VOLUME DISCOUNTS AVAILABLE | COOPERATIVE PURCHASING CONTRACT PRICING FOR 50 STATES

**PARTAC PEAT CORPORATION**  
 ONE KELSEY PARK, GREAT MEADOWS, NEW JERSEY 07838

800-247-BEAM (2326) • (908) 637-4191 • FAX (908) 637-8421  
 www.beamclay.com • sales@beamclay.com  
 Bid Term - 5/9/18 - 5/8/20; Extended to 5/8/21; Extended to 5/8/22



**Partac Peat Corporation – Item Price Schedule**  
**Athletic Equipment & Supplies BID# ESCNJ 17/18-31 Effective 5/9/2018 - 5/8/2022**

Bidding Company Name:				Partac Peat Corporation		Catalog Name:		10 - Volleyball Surfacing					
No.	Product Category	Beam Clay Catalog Section #	Page#	Product Description	Manufacturer	Vendor SKU	Unit of Measure	Catalog List Price	Bid Discount Percentage	Discount Amt.	Net Effective Bid Price	Comments	No.
1	Volleyball	10	2	White Beach Sand - Extra Fine - Bulk - SJ Plant #WEF-SJBU	Partac Peat Corporation	#WEF-SJBU	TON	\$ 27.000	5.0%	\$ 1.350	\$ 25.650	+ shipping - see freight notes	1
2	Volleyball	10	2	White Beach Sand - Extra White Fine - Bag - NJ Plant #XWF-NJBAG	Partac Peat Corporation	#XWF-NJBAG	50 LB BAG	\$ 5.500	5.0%	\$ 0.275	\$ 5.225	+ shipping - see freight notes	2
3	Volleyball	10	2	White Beach Sand - Medium - Bulk - SJ Plant #WM-SJBU	Partac Peat Corporation	#WM-SJBU	TON	\$ 25.000	5.0%	\$ 1.250	\$ 23.750	+ shipping - see freight notes	3
4	Volleyball	10	2	White Beach Sand - Medium - Bulk - NJ Plant #WM-NJBU	Partac Peat Corporation	#WM-NJBU	TON	\$ 45.000	5.0%	\$ 2.250	\$ 42.750	+ shipping - see freight notes	4
5	Volleyball	10	2	White Beach Sand - Medium Double Screened - Bulk - NJ Plant #WM-DS-NJBU	Partac Peat Corporation	#WM-DS-NJBU	TON	\$ 48.000	5.0%	\$ 2.400	\$ 45.600	+ shipping - see freight notes	5
6	Volleyball	10	2	White Beach Sand - Medium Double Screened - Bag - NJ Plant ##WM-DS-NJBAG	Partac Peat Corporation	##WM-DS-NJBAG	50 LB BAG	\$ 5.250	5.0%	\$ 0.263	\$ 4.988	+ shipping - see freight notes	6
7	Volleyball	10	2	White Beach Sand - Medium Heat-Treated - Bulk - NJ Plant #WM-HT-NJBU	Partac Peat Corporation	#WM-HT-NJBU	TON	\$ 69.000	5.0%	\$ 3.450	\$ 65.550	+ shipping - see freight notes	7
8	Volleyball	10	2	White Beach Sand - Medium Heat-Treated - Bag - NJ Plant #WM-HT-NJBAG	Partac Peat Corporation	#WM-HT-NJBAG	50 LB BAG	\$ 5.500	5.0%	\$ 0.275	\$ 5.225	+ shipping - see freight notes	8
9	Volleyball	10	2	White Beach Sand - Fine - Bulk - SJ Plant #WF-SJBU	Partac Peat Corporation	#WF-SJBU	TON	\$ 55.000	5.0%	\$ 2.750	\$ 52.250	+ shipping - see freight notes	9
10	Volleyball	10	2	White Beach Sand - Very Fine - Bulk - SJ Plant #WVF-SJBU	Partac Peat Corporation	#WVF-SJBU	TON	\$ 25.000	5.0%	\$ 1.250	\$ 23.750	+ shipping - see freight notes	10
11	Volleyball	10	2	White Beach Sand - Extra White Fine - Bag - NJ Plant #XWF-NJBAG	Partac Peat Corporation	#XWF-NJBAG	50 LB BAG	\$ 5.500	5.0%	\$ 0.275	\$ 5.225	+ shipping - see freight notes	11
12	Volleyball	10	2	White Beach Sand - Medium Fine - Bulk - SJ Plant #WMF-SJBU	Partac Peat Corporation	#WMF-SJBU	TON	\$ 27.000	5.0%	\$ 1.350	\$ 25.650	+ shipping - see freight notes	12
13	Volleyball	10	2	White Beach Sand - Medium Coarse - Bulk - SJ Plant #WMC-SJBU	Partac Peat Corporation	#WMC-SJBU	TON	\$ 29.000	5.0%	\$ 1.450	\$ 27.550	+ shipping - see freight notes	13
14	Volleyball	10	2	White Beach Sand - Bright White Crushed Marble / Medium Coarse - Bulk - MA Plant #SW-MC-MABU	Partac Peat Corporation	#SW-MC-MABU	TON	\$ 50.000	5.0%	\$ 2.500	\$ 47.500	+ shipping - see freight notes	14
15	Volleyball	10	2	White Beach Sand - 30/50 Heat-Treated - Bulk - SJ Plant #WHT3050-SJBU	Partac Peat Corporation	#WHT3050-SJBU	TON	\$ 88.000	5.0%	\$ 4.400	\$ 83.600	+ shipping - see freight notes	15
16	Volleyball	10	2	White Beach Sand - 30/50 Heat-Treated - 3,000 lb. Bulk Bag - SJ Plant #WHT3050-SJBB	Partac Peat Corporation	#WHT3050-SJBB	3,000 LB. BULK BAG	\$ 300.000	5.0%	\$ 15.000	\$ 285.000	+ shipping - see freight notes	16
17	Volleyball	10	2	White Beach Sand - 20/40 Heat Treated - Bulk - SJ Plant #WHT2040-SJBU	Partac Peat Corporation	#WHT2040-SJBU	TON	\$ 90.000	5.0%	\$ 4.500	\$ 85.500	+ shipping - see freight notes	17
18	Volleyball	10	2	White Beach Sand - 20/40 Heat Treated - 3,000 lb. Bulk Bag - SJ Plant #WHT2040-SJBB	Partac Peat Corporation	#WHT2040-SJBB	3,000 LB. BULK BAG	\$ 310.000	5.0%	\$ 15.500	\$ 294.500	+ shipping - see freight notes	18
19	Volleyball	10	2	White Beach Sand - 16/30 Heat Treated - Bulk - SJ Plant - #WHT1630-SJBU	Partac Peat Corporation	#WHT1630-SJBU	TON	\$ 100.000	5.0%	\$ 5.000	\$ 95.000	+ shipping - see freight notes	19
20	Volleyball	10	2	White Beach Sand - 16/30 Heat Treated - 3,00 lb. Bulk Bag - SJ Plant - #WHT1630-SJBB	Partac Peat Corporation	#WHT1630-SJBB	3,000 LB. BULK BAG	\$ 415.000	5.0%	\$ 20.750	\$ 394.250	+ shipping - see freight notes	20
21	Volleyball	10	2	White Beach Sand - 18/60 Heat-Treated - Bulk - SJ Plant #WHT1860-SJBU	Partac Peat Corporation	#WHT1860-SJBU	TON	\$ 70.000	5.0%	\$ 3.500	\$ 66.500	+ shipping - see freight notes	21
22	Volleyball	10	2	White Beach Sand - 18/60 Heat-Treated - 3,000 lb. Bulk Bag - SJ Plant #WHT1860-SJBB	Partac Peat Corporation	#WHT1860-SJBB	3,000 LB. BULK BAG	\$ 198.000	5.0%	\$ 9.900	\$ 188.100	+ shipping - see freight notes	22
23	Volleyball	10	2	White Beach Sand - 18/100 Heat-Treated - Bulk - SJ Plant #WHT18100-SJBU	Partac Peat Corporation	#WHT18100-SJBU	TON	\$ 65.000	5.0%	\$ 3.250	\$ 61.750	+ shipping - see freight notes	23
24	Volleyball	10	2	White Beach Sand - 18/100 Heat-Treated - 3,000 lb. Bulk Bag - SJ Plant #WHT18100-SJBB	Partac Peat Corporation	#WHT18100-SJBB	3,000 LB. BULK BAG	\$ 175.000	5.0%	\$ 8.750	\$ 166.250	+ shipping - see freight notes	24
25	Volleyball	10	2	White Beach Sand - 35/70 Heat-Treated - Bulk - SJ Plant #WHT3570-SJBU	Partac Peat Corporation	#WHT3570-SJBU	TON	\$ 70.000	5.0%	\$ 3.500	\$ 66.500	+ shipping - see freight notes	25
26	Volleyball	10	2	White Beach Sand - 35/70 Heat-Treated - 3,000 lb. Bulk Bag - SJ Plant #WHT3570-SJBB	Partac Peat Corporation	#WHT3570-SJBB	3,000 LB. BULK BAG	\$ 190.000	5.0%	\$ 9.500	\$ 180.500	+ shipping - see freight notes	26
27	Volleyball	10	2	White Beach Sand - 35/100 Heat-Treated - Bulk - SJ Plant #WHT35100-SJBU	Partac Peat Corporation	#WHT35100-SJBU	TON	\$ 50.000	5.0%	\$ 2.500	\$ 47.500	+ shipping - see freight notes	27
28	Volleyball	10	2	White Beach Sand - 35/100 Heat-Treated - 3,000 lb. Bulk Bag - SJ Plant #WHT35100-SJBB	Partac Peat Corporation	#WHT35100-SJBB	3,000 LB. BULK BAG	\$ 170.000	5.0%	\$ 8.500	\$ 161.500	+ shipping - see freight notes	28
29	Volleyball	10	2	White Beach Sand - 40/100 Heat-Treated - Bulk - SJ Plant #WHT40100-SJBU	Partac Peat Corporation	#WHT40100-SJBU	TON	\$ 88.000	5.0%	\$ 4.400	\$ 83.600	+ shipping - see freight notes	29

Bidding Company Name:				Partac Peat Corporation	Catalog Name:		10 - Volleyball Surfacing						
No.	Product Category	Beam Clay Catalog Section #	Page#	Product Description	Manufacturer	Vendor SKU	Unit of Measure	Catalog List Price	Bid Discount Percentage	Discount Amt.	Net Effective Bid Price	Comments	No.
30	Volleyball	10	2	White Beach Sand - 40/100 Heat-Treated - 3,000 LB. Bulk Bag - SJ Plant #WHT40100-SJBU	Partac Peat Corporation	#WHT40100SJB8	3,000 LB. BULK BAG	\$ 335.000	5.0%	\$ 16.750	\$ 318.250	+ shipping - see freight notes	30
31	Volleyball	10	4	Rubber Curbing - 4" High x 3" Wide x 6' Long (30 lbs./piece, up to 100 pieces/pallet) #RC-4X3X6	RubbeRecycle	#RC-4X3X6	PIECE	\$ 36.000	5.0%	\$ 1.800	\$ 34.200	+ shipping - see freight notes	31
32	Volleyball	10	4	Rubber Curbing - 6" High x 4" Wide x 6' Long (45 lbs./piece, up to 63 pieces/pallet) #RC-6X4X6	RubbeRecycle	#RC-6X4X6	PIECE	\$ 65.000	5.0%	\$ 3.250	\$ 61.750	+ shipping - see freight notes	32
33	Volleyball	10	4	Rubber Curbing - 8" High x 4" Wide x 6' Long (70 lbs./piece, up to 45 pieces/pallet) #RC-8X4X6	RubbeRecycle	#RC-8X4X6	PIECE	\$ 82.000	5.0%	\$ 4.100	\$ 77.900	+ shipping - see freight notes	33
34	Volleyball	10	4	Rubber Curbing - 4" High x 4" Wide x 6' Long (70 lbs./piece, up to 45 pieces/pallet) #RC-4X4X6	RubbeRecycle	#RC-4X4X6	PIECE	\$ 35.000	5.0%	\$ 1.750	\$ 33.250	+ shipping - see freight notes	34
35	Volleyball	10	4	Rubber Curbing - 4" High x 3" Wide x 4' Long (14 lbs./piece, up to 140 pieces/pallet) #RC-4X3X4	RubbeRecycle	#RC-4X3X4	PIECE	\$ 20.000	5.0%	\$ 1.000	\$ 19.000	+ shipping - see freight notes	35
36	Volleyball	10	various	FULL OR PARTIAL PALLETS: PALLET & COVER CHARGES FROM NJ	Partac Peat Corporation	NJ-PALLET	EACH	\$ 6.500	5.0%	\$ 0.325	\$ 6.175	+ shipping - see freight notes	36
37	Volleyball	10	6	Coastal Competition Volleyball System - System - #OCC-500	Jaypro	#OCC-500	SYSTEM	\$ 1,503.000	5.0%	\$ 75.150	\$ 1,427.850	+ shipping - see freight notes	37
38	Volleyball	10	6	Coastal Competition Volleyball System -Replacement Net - #OCC-500N	Jaypro	#OCC-500N	EACH	\$ 196.000	5.0%	\$ 9.800	\$ 186.200	+ shipping - see freight notes	38
39	Volleyball	10	6	Outdoor Competition Volleyball System - System - #OCV-900	Jaypro	#OCV-900	SYSTEM	\$ 1,116.000	5.0%	\$ 55.800	\$ 1,060.200	+ shipping - see freight notes	39
40	Volleyball	10	6	Outdoor Competition Volleyball System - Center Package - #OCV-900C	Jaypro	#OCV-900C	EACH	\$ 651.000	5.0%	\$ 32.550	\$ 618.450	+ shipping - see freight notes	40
41	Volleyball	10	6	Recreational Outdoor Volleyball System - #OS-350	Jaypro	#OS-350	SYSTEM	\$ 632.000	5.0%	\$ 31.600	\$ 600.400	+ shipping - see freight notes	41
42	Volleyball	10	6	Adjustable Volleyball Court Line #AVCL-2	Jaypro	#AVCL-2	EACH	\$ 57.000	5.0%	\$ 2.850	\$ 54.150	+ shipping - see freight notes	42
43	Volleyball	10	7	Mercury™ Beach Volleyball Net - 3-1/2" Aluminum - Complete System - includes Official Net - #OBV100-OFF	Jaypro	#OBV100-OFF	EACH	\$ 2,822.000	5.0%	\$ 141.100	\$ 2,680.900	+ shipping - see freight notes	43
44	Volleyball	10	7	Mercury™ Beach Volleyball Net - 3-1/2" Aluminum - Complete System - includes Recreational Net - #OBV100-REC	Jaypro	#OBV100-REC	EACH	\$ 2,822.000	5.0%	\$ 141.100	\$ 2,680.900	+ shipping - see freight notes	44
45	Volleyball	10	7	Mercury™ Beach Volleyball Net - 3-1/2" Aluminum - Uprights only -includes winch - #OBV100U	Jaypro	#OBV100U	PAIR	\$ 2,022.000	5.0%	\$ 101.100	\$ 1,920.900	+ shipping - see freight notes	45
46	Volleyball	10	7	Mercury™ Beach Volleyball Net -- Ground Inserts - #OBV-100AK	Jaypro	#OBV-100AK	PAIR	\$ 559.000	5.0%	\$ 27.950	\$ 531.050	+ shipping - see freight notes	46
47	Volleyball	10	7	Mercury™ Beach Volleyball Net -- Official Competition Net - #OBVN-1	Jaypro	#OBVN-1	EACH	\$ 414.000	5.0%	\$ 20.700	\$ 393.300	+ shipping - see freight notes	47
48	Volleyball	10	7	Mercury™ Beach Volleyball Net -- Recreational Size Net - #OBVN-2	Jaypro	#OBVN-2	EACH	\$ 282.000	5.0%	\$ 14.100	\$ 267.900	+ shipping - see freight notes	48
49	Volleyball	10	8	POWERLite™ Volleyball System Package - 3-1/2" System - #PVB-7PKG	Jaypro	#PVB-7PKG	PKG	\$ 4,527.000	5.0%	\$ 226.350	\$ 4,300.650	+ shipping - see freight notes	49
50	Volleyball	10	8	POWERLite™ Volleyball System Package - 3" System - #PVB-6PKG	Jaypro	#PVB-6PKG	PKG	\$ 4,527.000	5.0%	\$ 226.350	\$ 4,300.650	+ shipping - see freight notes	50
51	Volleyball	10	8	POWERLite™ Deluxe Volleyball System Package - 3-1/2" System - #PVB-7PKGDX	Jaypro	#PVB-7PKGDX	PKG	\$ 4,766.000	5.0%	\$ 238.300	\$ 4,527.700	+ shipping - see freight notes	51
52	Volleyball	10	8	POWERLite™ Deluxe Volleyball System Package - 3" System - #PVB-6PKGDX	Jaypro	#PVB-6PKGDX	PKG	\$ 4,766.000	5.0%	\$ 238.300	\$ 4,527.700	+ shipping - see freight notes	52
53	Volleyball	10	9	FEATHERLite™ Volleyball System Package - 3-1/2" System - #PVB-5PKG	Jaypro	#PVB-5PKG	PKG	\$ 3,761.000	5.0%	\$ 188.050	\$ 3,572.950	+ shipping - see freight notes	53
54	Volleyball	10	9	FEATHERLite™ Volleyball System Package - 3" System - #PVB-4PKG	Jaypro	#PVB-4PKG	PKG	\$ 3,761.000	5.0%	\$ 188.050	\$ 3,572.950	+ shipping - see freight notes	54
55	Volleyball	10	9	FEATHERLite™ Deluxe Volleyball System Package - 3-1/2" System - #PVB-5PKGDX	Jaypro	#PVB-5PKGDX	PKG	\$ 4,050.000	5.0%	\$ 202.500	\$ 3,847.500	+ shipping - see freight notes	55
56	Volleyball	10	9	FEATHERLite™ Deluxe Volleyball System Package - 3" System - #PVB-4PKGDX	Jaypro	#PVB-4PKGDX	PKG	\$ 4,050.000	5.0%	\$ 202.500	\$ 3,847.500	+ shipping - see freight notes	56
57	Volleyball	10	10	POWERLite™ Volleyball Systems - 3" Complete System #PVB-6500	Jaypro	#PVB-6500	SYSTEM	\$ 3,692.000	5.0%	\$ 184.600	\$ 3,507.400	+ shipping - see freight notes	57
58	Volleyball	10	10	POWERLite™ Volleyball Systems - 3-1/2" Complete System #PVB-7000	Jaypro	#PVB-7000	SYSTEM	\$ 3,692.000	5.0%	\$ 184.600	\$ 3,507.400	+ shipping - see freight notes	58
59	Volleyball	10	10	POWERLite™ Volleyball Systems - 3" System - Uprights Only #PVB-65U	Jaypro	#PVB-65U	PAIR	\$ 2,737.000	5.0%	\$ 136.850	\$ 2,600.150	+ shipping - see freight notes	59
60	Volleyball	10	10	POWERLite™ Volleyball Systems - 3-1/2" System - Uprights Only #PVB-70U	Jaypro	#PVB-70U	PAIR	\$ 2,737.000	5.0%	\$ 136.850	\$ 2,600.150	+ shipping - see freight notes	60

Bidding Company Name:				Partac Peat Corporation	Catalog Name:		10 - Volleyball Surfacing					No.	
No.	Product Category	Beam Clay Catalog Section #	Page#	Product Description	Manufacturer	Vendor SKU	Unit of Measure	Catalog List Price	Bid Discount Percentage	Discount Amt.	Net Effective Bid Price	Comments	No.
61	Volleyball	10	10	POWERLite™ Volleyball Systems - 3" System - Center Package - #PVBC-650	Jaypro	#PVBC-650	EACH	\$ 2,773.000	5.0%	\$ 138.650	\$ 2,634.350	+ shipping - see freight notes	61
62	Volleyball	10	10	POWERLite™ Volleyball Systems - 3-1/2" System - Center Package - #PVBC-700	Jaypro	#PVBC-700	EACH	\$ 2,773.000	5.0%	\$ 138.650	\$ 2,634.350	+ shipping - see freight notes	62
63	Volleyball	10	11	FEATHERLite™ Volleyball Systems - 3" Complete System #PVB-4500	Jaypro	#PVB-4500	SYSTEM	\$ 3,009.000	5.0%	\$ 150.450	\$ 2,858.550	+ shipping - see freight notes	63
64	Volleyball	10	11	FEATHERLite™ Volleyball Systems - 3-1/2" Complete System #PVB-5000	Jaypro	#PVB-5000	SYSTEM	\$ 3,009.000	5.0%	\$ 150.450	\$ 2,858.550	+ shipping - see freight notes	64
65	Volleyball	10	11	FEATHERLite™ Volleyball Systems - 3" System - Uprights Only #PVB-45U	Jaypro	#PVB-45U	PAIR	\$ 1,938.000	5.0%	\$ 96.900	\$ 1,841.100	+ shipping - see freight notes	65
66	Volleyball	10	11	FEATHERLite™ Volleyball Systems - 3-1/2" System - Uprights Only #PVB-51U	Jaypro	#PVB-51U	PAIR	\$ 1,903.000	5.0%	\$ 95.150	\$ 1,807.850	+ shipping - see freight notes	66
67	Volleyball	10	11	FEATHERLite™ Volleyball Systems - 3" System -Center Package #PVBC-450	Jaypro	#PVBC-450	PKG	\$ 2,087.000	5.0%	\$ 104.350	\$ 1,982.650	+ shipping - see freight notes	67
68	Volleyball	10	11	FEATHERLite™ Volleyball Systems - 3-1/2" System -Center Package #PVBC-500	Jaypro	#PVBC-500	PKG	\$ 2,087.000	5.0%	\$ 104.350	\$ 1,982.650	+ shipping - see freight notes	68
69	Volleyball	10	12	CARBON VOLLEYBALL SYSTEMS - Lady Pro Carbon - 3" Complete System #PVB-8500	Jaypro	#PVB-8500	SYSTEM	\$ 4,766.000	5.0%	\$ 238.300	\$ 4,527.700	+ shipping - see freight notes	69
70	Volleyball	10	12	CARBON VOLLEYBALL SYSTEMS - Lady Pro Carbon - 3-1/2" Complete System #PVB-8000	Jaypro	#PVB-8000	SYSTEM	\$ 4,766.000	5.0%	\$ 238.300	\$ 4,527.700	+ shipping - see freight notes	70
71	Volleyball	10	12	CARBON VOLLEYBALL SYSTEMS - Lady Pro Carbon - 3" System - Upright Only #PVB-85U	Jaypro	#PVB-85U	PAIR	\$ 3,384.000	5.0%	\$ 169.200	\$ 3,214.800	+ shipping - see freight notes	71
72	Volleyball	10	12	CARBON VOLLEYBALL SYSTEMS - Lady Pro Carbon - 3-1/2" System - Upright Only #PVB-80U	Jaypro	#PVB-80U	PAIR	\$ 3,384.000	5.0%	\$ 169.200	\$ 3,214.800	+ shipping - see freight notes	72
73	Volleyball	10	12	CARBON VOLLEYBALL SYSTEMS - Lady Pro Carbon - 3" System - Center Package #PVBC-850	Jaypro	#PVBC-850	PKG	\$ 3,009.000	5.0%	\$ 150.450	\$ 2,858.550	+ shipping - see freight notes	73
74	Volleyball	10	12	CARBON VOLLEYBALL SYSTEMS - Lady Pro Carbon - 3-1/2" System - Center Package #PVBC-800	Jaypro	#PVBC-800	PKG	\$ 3,009.000	5.0%	\$ 150.450	\$ 2,858.550	+ shipping - see freight notes	74
75	Volleyball	10	12	CARBON VOLLEYBALL SYSTEMS - Carbon Ultralite - 3" Complete System #PVB-9500	Jaypro	#PVB-9500	SYSTEM	\$ 5,017.000	5.0%	\$ 250.850	\$ 4,766.150	+ shipping - see freight notes	75
76	Volleyball	10	12	CARBON VOLLEYBALL SYSTEMS - Carbon Ultralite - 3-1/2" Complete System #PVB-9000	Jaypro	#PVB-9000	SYSTEM	\$ 5,017.000	5.0%	\$ 250.850	\$ 4,766.150	+ shipping - see freight notes	76
77	Volleyball	10	12	CARBON VOLLEYBALL SYSTEMS - Carbon Ultralite - 3" System - Uprights Only #PVB-95U	Jaypro	#PVB-95U	PAIR	\$ 4,138.000	5.0%	\$ 206.900	\$ 3,931.100	+ shipping - see freight notes	77
78	Volleyball	10	12	CARBON VOLLEYBALL SYSTEMS - Carbon Ultralite - 3-1/2" System - Uprights Only #PVB-90U	Jaypro	#PVB-90U	PAIR	\$ 4,138.000	5.0%	\$ 206.900	\$ 3,931.100	+ shipping - see freight notes	78
79	Volleyball	10	12	CARBON VOLLEYBALL SYSTEMS - Carbon Ultralite - 3" System - Center Package #PVBC-950	Jaypro	#PVBC-950	PKG	\$ 3,134.000	5.0%	\$ 156.700	\$ 2,977.300	+ shipping - see freight notes	79
80	Volleyball	10	12	CARBON VOLLEYBALL SYSTEMS - Carbon Ultralite - 3-1/2" System - Center Package #PVBC-900	Jaypro	#PVBC-900	PKG	\$ 3,134.000	5.0%	\$ 156.700	\$ 2,977.300	+ shipping - see freight notes	80
81	Volleyball	10	12	Competition Badminton System - Badminton System, PAIR #BSO-2U	Jaypro	#BSO-2U	PAIR	\$ 272.000	5.0%	\$ 13.600	\$ 258.400	+ shipping - see freight notes	81
82	Volleyball	10	12	Competition Badminton System - Badminton Net, EACH #BND-1	Jaypro	#BND-1	EACH	\$ 61.000	5.0%	\$ 3.050	\$ 57.950	+ shipping - see freight notes	82
83	Volleyball	10	12	Competition Badminton System - Floor Sleeve & Brass Cover, PAIR #BSO-2G	Jaypro	#BSO-2G	PAIR	\$ 385.000	5.0%	\$ 19.250	\$ 365.750	+ shipping - see freight notes	83
84	Volleyball	10	12	Competition Badminton System - Floor Sleeve & Chrome Cover, PAIR #BSO-2G-CP	Jaypro	#BSO-2G-CP	PAIR	\$ 282.000	5.0%	\$ 14.100	\$ 267.900	+ shipping - see freight notes	84
85	Volleyball	10	13	Hybrid Collegiate Net Systems - 3" Complete System #PVB-3000	Jaypro	#PVB-3000	SYSTEM	\$ 2,534.000	5.0%	\$ 126.700	\$ 2,407.300	+ shipping - see freight notes	85
86	Volleyball	10	13	Hybrid Collegiate Net Systems - 3-1/2" Complete System #PVB-1500	Jaypro	#PVB-1500	SYSTEM	\$ 2,534.000	5.0%	\$ 126.700	\$ 2,407.300	+ shipping - see freight notes	86
87	Volleyball	10	13	Hybrid Collegiate Net Systems - 3" System - Uprights Only #PVB-30U	Jaypro	#PVB-30U	PAIR	\$ 1,664.000	5.0%	\$ 83.200	\$ 1,580.800	+ shipping - see freight notes	87
88	Volleyball	10	13	Hybrid Collegiate Net Systems - 3-1/2" System - Uprights Only #PVB-150U	Jaypro	#PVB-150U	PAIR	\$ 1,664.000	5.0%	\$ 83.200	\$ 1,580.800	+ shipping - see freight notes	88
89	Volleyball	10	13	Hybrid Collegiate Net Systems - 3" System - Center Package #PVBC-300	Jaypro	#PVBC-300	PKG	\$ 1,664.000	5.0%	\$ 83.200	\$ 1,580.800	+ shipping - see freight notes	89
90	Volleyball	10	13	Hybrid Collegiate Net Systems - 3-1/2" System - Center Package #PVBC-150	Jaypro	#PVBC-150	PKG	\$ 1,664.000	5.0%	\$ 83.200	\$ 1,580.800	+ shipping - see freight notes	90
91	Volleyball	10	13	Multi-Purpose Net System - 3-1/2" Complete System #PVB-1350	Jaypro	#PVB-1350	SYSTEM	\$ 2,311.000	5.0%	\$ 115.550	\$ 2,195.450	+ shipping - see freight notes	91



Bidding Company Name:				Partac Peat Corporation	Catalog Name:		10 - Volleyball Surfacing					No.	
No.	Product Category	Beam Clay Catalog Section #	Page#	Product Description	Manufacturer	Vendor SKU	Unit of Measure	Catalog List Price	Bid Discount Percentage	Discount Amt.	Net Effective Bid Price	Comments	No.
92	Volleyball	10	13	Multi-Purpose Net System - 3-1/2" System - Uprights Only #PVB-13U	Jaypro	#PVB-13U	PAIR	\$ 1,597.000	5.0%	\$ 79.850	\$ 1,517.150	+ shipping - see freight notes	92
93	Volleyball	10	13	Multi-Purpose Net System - 3-1/2" System - Center Package #PVBC-130	Jaypro	#PVBC-130	PKG	\$ 1,489.000	5.0%	\$ 74.450	\$ 1,414.550	+ shipping - see freight notes	93
94	Volleyball	10	13	Multi-Purpose Net System - 2" Complete System (Canadian Size) #PVB-1250	Jaypro	#PVB-1250	SYSTEM	\$ 2,377.000	5.0%	\$ 118.850	\$ 2,258.150	+ shipping - see freight notes	94
95	Volleyball	10	13	Multi-Purpose Net System - 2" System (Canadian Size) - Uprights Only #PVB-12U	Jaypro	#PVB-12U	PAIR	\$ 1,717.000	5.0%	\$ 85.850	\$ 1,631.150	+ shipping - see freight notes	95
96	Volleyball	10	14	Second Floor Competition Net Systems - Infinite Complete System #PVB-2700	Jaypro	#PVB-2700	SYSTEM	\$ 4,066.000	5.0%	\$ 203.300	\$ 3,862.700	+ shipping - see freight notes	96
97	Volleyball	10	14	Second Floor Competition Net Systems - Pin Stop Complete System #PVB-2500	Jaypro	#PVB-2500	SYSTEM	\$ 3,533.000	5.0%	\$ 176.650	\$ 3,356.350	+ shipping - see freight notes	97
98	Volleyball	10	14	Second Floor Competition Net Systems - Infinite System - Uprights Only #PVB-270UB	Jaypro	#PVB-270UB	PAIR	\$ 3,199.000	5.0%	\$ 159.950	\$ 3,039.050	+ shipping - see freight notes	98
99	Volleyball	10	14	Second Floor Competition Net Systems - Pin Stop System - Uprights Only #PVB-250UB	Jaypro	#PVB-250UB	PAIR	\$ 2,162.000	5.0%	\$ 108.100	\$ 2,053.900	+ shipping - see freight notes	99
100	Volleyball	10	14	Second Floor Competition Net Systems - Infinite System - Center Package #PVBC-270	Jaypro	#PVBC-270	PKG	\$ 3,327.000	5.0%	\$ 166.350	\$ 3,160.650	+ shipping - see freight notes	100
101	Volleyball	10	14	Second Floor Competition Net Systems - Pin Stop System - Center Package #PVBC-250	Jaypro	#PVBC-250	PKG	\$ 2,312.000	5.0%	\$ 115.600	\$ 2,196.400	+ shipping - see freight notes	101
102	Volleyball	10	14	Replacement Base Pad #PVB-25P	Jaypro	#PVB-25P	PAIR	\$ 357.000	5.0%	\$ 17.850	\$ 339.150	+ shipping - see freight notes	102
103	Volleyball	10	14	Cable/Buckle Cover #VCC-12	Jaypro	#VCC-12	PAIR	\$ 71.000	5.0%	\$ 3.550	\$ 67.450	+ shipping - see freight notes	103
104	Volleyball	10	14	Universal Antennas #VBA-80	Jaypro	#VBA-80	PAIR	\$ 143.000	5.0%	\$ 7.150	\$ 135.850	+ shipping - see freight notes	104
105	Volleyball	10	14	Antennas #VBA-4	Jaypro	#VBA-4	PAIR	\$ 136.000	5.0%	\$ 6.800	\$ 129.200	+ shipping - see freight notes	105
106	Volleyball	10	14	Boundary Tape #VA-22	Jaypro	#VA-22	PAIR	\$ 28.000	5.0%	\$ 1.400	\$ 26.600	+ shipping - see freight notes	106
107	Volleyball	10	15	Flex Net™ - Net Size 32'L x 39"H #PVB-6	Jaypro	#PVB-6	EACH	\$ 514.000	5.0%	\$ 25.700	\$ 488.300	+ shipping - see freight notes	107
108	Volleyball	10	15	Flex Net™ - (with Adapter Cord) #PVB-6AK	Jaypro	#PVB-6AK	EACH	\$ 576.000	5.0%	\$ 28.800	\$ 547.200	+ shipping - see freight notes	108
109	Volleyball	10	15	Flex Net™ - (with Adapter Strap) #PVB-6J	Jaypro	#PVB-6J	EACH	\$ 576.000	5.0%	\$ 28.800	\$ 547.200	+ shipping - see freight notes	109
110	Volleyball	10	15	Premium Net - 3.5mm Knotless Poly Net 32'L x 39"H #PVB-5	Jaypro	#PVB-5	EACH	\$ 306.000	5.0%	\$ 15.300	\$ 290.700	+ shipping - see freight notes	110
111	Volleyball	10	15	Collegiate Net - 32'L x 39"H #21 nylon net w/coated steel cable #PVB-3	Jaypro	#PVB-3	EACH	\$ 240.000	5.0%	\$ 12.000	\$ 228.000	+ shipping - see freight notes	111
112	Volleyball	10	15	Volleyball Net - 32'L x 36"H 2.5mm poly net w/coated steel cable #VBD-3	Jaypro	#VBD-3	EACH	\$ 86.000	5.0%	\$ 4.300	\$ 81.700	+ shipping - see freight notes	112
113	Volleyball	10	15	Volleyball Net - 32'L x 36"H Nylon net w/rope cable #VBN-32	Jaypro	#VBN-32	EACH	\$ 93.000	5.0%	\$ 4.650	\$ 88.350	+ shipping - see freight notes	113
114	Volleyball	10	16	Single Net Keeper #VVK11	Jaypro	#VVK11	EACH	\$ 235.000	5.0%	\$ 11.750	\$ 223.250	+ shipping - see freight notes	114
115	Volleyball	10	16	Double Net Keeper #VVK22	Jaypro	#VVK22	EACH	\$ 274.000	5.0%	\$ 13.700	\$ 260.300	+ shipping - see freight notes	115
116	Volleyball	10	16	Triple Net Keeper #VVK33	Jaypro	#VVK33	EACH	\$ 314.000	5.0%	\$ 15.700	\$ 298.300	+ shipping - see freight notes	116
117	Volleyball	10	16	Net Keeper Storage Bag #VVKBAG	Jaypro	#VVKBAG	EACH	\$ 35.000	5.0%	\$ 1.750	\$ 33.250	+ shipping - see freight notes	117
118	Volleyball	10	16	Custom Volleyball Net Tape - Top Net Tape #CVNT-1	Jaypro	#CVNT-1	EACH	\$ 292.000	5.0%	\$ 14.600	\$ 277.400	+ shipping - see freight notes	118
119	Volleyball	10	16	Custom Volleyball Net Tape - Side Net Tape #CVNT-2	Jaypro	#CVNT-2	PAIR	\$ 160.000	5.0%	\$ 8.000	\$ 152.000	+ shipping - see freight notes	119
120	Volleyball	10	17	"MEGA REF" Folding Referee Stand #VRS-8000	Jaypro	#VRS-8000	EACH	\$ 935.000	5.0%	\$ 46.750	\$ 888.250	+ shipping - see freight notes	120
121	Volleyball	10	17	Folding Referee Stand #VRS-6000	Jaypro	#VRS-6000	EACH	\$ 650.000	5.0%	\$ 32.500	\$ 617.500	+ shipping - see freight notes	121
122	Volleyball	10	17	Adjustable Referee Stand #VRS-3000	Jaypro	#VRS-3000	EACH	\$ 735.000	5.0%	\$ 36.750	\$ 698.250	+ shipping - see freight notes	122

Bidding Company Name:				Partac Peat Corporation	Catalog Name:		10 - Volleyball Surfacing					No.	
No.	Product Category	Beam Clay Catalog Section #	Page#	Product Description	Manufacturer	Vendor SKU	Unit of Measure	Catalog List Price	Bid Discount Percentage	Discount Amt.	Net Effective Bid Price	Comments	No.
123	Volleyball	10	17	Beach Volleyball Referee Stand #OBVRS-8	Jaypro	#OBVRS-8	EACH	\$ 1,215.000	5.0%	\$ 60.750	\$ 1,154.250	+ shipping - see freight notes	123
124	Volleyball	10	17	Beach Volleyball Referee Stand Custom Side Banners #CVNT-3	Jaypro	#CVNT-3	PAIR	\$ 285.000	5.0%	\$ 14.250	\$ 270.750	+ shipping - see freight notes	124
125	Volleyball	10	18	Official Upright Pads #PVB-60P	Jaypro	#PVB-60P	PAIR	\$ 565.000	5.0%	\$ 28.250	\$ 536.750	+ shipping - see freight notes	125
126	Volleyball	10	18	Referee Stand Padding #VRS-60P	Jaypro	#VRS-60P	EACH	\$ 330.000	5.0%	\$ 16.500	\$ 313.500	+ shipping - see freight notes	126
#REF!	Volleyball	10	18	Custom Graphics for Upright Pad - Multi-color custom lettering with graphic #JSG-VPP	Jaypro	#JSG-VPP	PAD	\$ 246.000	5.0%	\$ 12.300	\$ 233.700	+ shipping - see freight notes	#REF!
#REF!	Volleyball	10	18	Volleyball Equipment Carrier - 42"L x 32"W - (4 poles) #EC-500	Jaypro	#EC-500	EACH	\$ 375.000	5.0%	\$ 18.750	\$ 356.250	+ shipping - see freight notes	#REF!
#REF!	Volleyball	10	18	Volleyball Equipment Carrier - 48"L x 36"W - (6 poles) #EC-1000	Jaypro	#EC-1000	EACH	\$ 501.000	5.0%	\$ 25.050	\$ 475.950	+ shipping - see freight notes	#REF!
#REF!	Volleyball	10	18	Volleyball Equipment Carrier - 60"L x 35"W - (6 poles) #VEC-1	Jaypro	#VEC-1	EACH	\$ 476.000	5.0%	\$ 23.800	\$ 452.200	+ shipping - see freight notes	#REF!
#REF!	Volleyball	10	19	Brass Sleeve & Cover 3-1/2" #PVB-75S	Jaypro	#PVB-75S	PAIR	\$ 371.000	5.0%	\$ 18.550	\$ 352.450	+ shipping - see freight notes	#REF!
#REF!	Volleyball	10	19	Chrome Sleeve & Cover 3-1/2" #PVB-75S-CP	Jaypro	#PVB-75S-CP	PAIR	\$ 408.000	5.0%	\$ 20.400	\$ 387.600	+ shipping - see freight notes	#REF!
#REF!	Volleyball	10	19	Brass Sleeve & Cover 3" #PVB-70S	Jaypro	#PVB-70S	PAIR	\$ 371.000	5.0%	\$ 18.550	\$ 352.450	+ shipping - see freight notes	#REF!
#REF!	Volleyball	10	19	Chrome Sleeve & Cover 3" #PVB-70S-CP	Jaypro	#PVB-70S-CP	PAIR	\$ 408.000	5.0%	\$ 20.400	\$ 387.600	+ shipping - see freight notes	#REF!
#REF!	Volleyball	10	19	Brass Sleeve & Cover 2-3/8" #BSO-2G	Jaypro	#BSO-2G	PAIR	\$ 385.000	5.0%	\$ 19.250	\$ 365.750	+ shipping - see freight notes	#REF!
#REF!	Volleyball	10	19	Chrome Sleeve & Cover 2-3/8" #BSO-2G-CP	Jaypro	#BSO-2G-CP	PAIR	\$ 282.000	5.0%	\$ 14.100	\$ 267.900	+ shipping - see freight notes	#REF!
#REF!	Volleyball	10	19	Brass Cover Plate 7-1/2" #PVB-711	Jaypro	#PVB-711	EACH	\$ 226.000	5.0%	\$ 11.300	\$ 214.700	+ shipping - see freight notes	#REF!
#REF!	Volleyball	10	19	Chrome Cover Plate 7-1/2" #PVB-75CVR-CP	Jaypro	#PVB-75CVR-CP	EACH	\$ 243.000	5.0%	\$ 12.150	\$ 230.850	+ shipping - see freight notes	#REF!
#REF!	Volleyball	10	19	Brass Cover Plate 8-1/2" #PVB-85CVR	Jaypro	#PVB-85CVR	EACH	\$ 243.000	5.0%	\$ 12.150	\$ 230.850	+ shipping - see freight notes	#REF!
#REF!	Volleyball	10	19	Sleeve Insert #PVB-DEP	Jaypro	#PVB-DEP	EACH	\$ 92.000	5.0%	\$ 4.600	\$ 87.400	+ shipping - see freight notes	#REF!
#REF!	Volleyball	10	19	Sleeve Insert/Adapter Modifies 3" ID to 2-3/8" ID #SVL-3238	Jaypro	#SVL-3238	EACH	\$ 82.000	5.0%	\$ 4.100	\$ 77.900	+ shipping - see freight notes	#REF!
#REF!	Volleyball	10	19	Sleeve Insert/Adapter Modifies 3-1/2" ID to 3" ID #PVB-ID	Jaypro	#PVB-ID	EACH	\$ 82.000	5.0%	\$ 4.100	\$ 77.900	+ shipping - see freight notes	#REF!
#REF!	Volleyball	10	19	Sleeve Insert/Adapter Modifies 3-1/2" ID to 2-3/8" ID #SVL-3528	Jaypro	#SVL-3528	EACH	\$ 88.000	5.0%	\$ 4.400	\$ 83.600	+ shipping - see freight notes	#REF!
#REF!	Volleyball	10	19	Sleeve Insert/Adapter Modifies 3-7/8" ID TO 3-1/2" ID #SVL-37835	Jaypro	SVL-37835	EACH	\$ 45.000	5.0%	\$ 2.250	\$ 42.750	+ shipping - see freight notes	#REF!
#REF!	Volleyball	10	19	Sleeve Insert/Adapter Modifies 4" ID to 3-1/2" ID #SVL-4035	Jaypro	#SVL-4035	EACH	\$ 74.000	5.0%	\$ 3.700	\$ 70.300	+ shipping - see freight notes	#REF!
#REF!	Volleyball	10	20	Floor Anchor (1-1/4" Cylinder) #FP-89	Jaypro	#FP-89	EACH	\$ 136.000	5.0%	\$ 6.800	\$ 129.200	+ shipping - see freight notes	#REF!
#REF!	Volleyball	10	20	Floor Anchor (1-1/4" Cylinder) #FP-90	Jaypro	#FP-90	EACH	\$ 119.000	5.0%	\$ 5.950	\$ 113.050	+ shipping - see freight notes	#REF!
#REF!	Volleyball	10	20	Floating Wood Floor Anchor (1-1/4" Cylinder) #FP-100	Jaypro	#FP-100	EACH	\$ 146.000	5.0%	\$ 7.300	\$ 138.700	+ shipping - see freight notes	#REF!
#REF!	Volleyball	10	20	Second Floor Sleeve Bracket #SB-10	Jaypro	#SB-10	EACH	\$ 300.000	5.0%	\$ 15.000	\$ 285.000	+ shipping - see freight notes	#REF!
#REF!	Volleyball	10	20	Wall Rack #VBWR-1	Jaypro	#VBWR-1	EACH	\$ 187.000	5.0%	\$ 9.350	\$ 177.650	+ shipping - see freight notes	#REF!
#REF!	Volleyball	10	21	Hammock Drill Cart #HSVBC24	Jaypro	#HSVBC24	EACH	\$ 151.000	5.0%	\$ 7.550	\$ 143.450	+ shipping - see freight notes	#REF!
#REF!	Volleyball	10	21	ToteMaster™ Open Top #TE-PE01	Jaypro	#TE-PE01	EACH	\$ 275.000	5.0%	\$ 13.750	\$ 261.250	+ shipping - see freight notes	#REF!
#REF!	Volleyball	10	21	Deluxe 15 Ball Carrier - Royal Blue #BBC-12RB	Jaypro	#BBC-12RB	EACH	\$ 110.000	5.0%	\$ 5.500	\$ 104.500	+ shipping - see freight notes	#REF!

Bidding Company Name:				Partac Peat Corporation		Catalog Name:		10 - Volleyball Surfacing				No.	
No.	Product Category	Beam Clay Catalog Section #	Page#	Product Description	Manufacturer	Vendor SKU	Unit of Measure	Catalog List Price	Bid Discount Percentage	Discount Amt.	Net Effective Bid Price	Comments	No.
#REF!	Volleyball	10	21	Deluxe 15 Ball Carrier - Black #BBC-12BK	Jaypro	#BBC-12BK	EACH	\$ 110.000	5.0%	\$ 5.500	\$ 104.500	+ shipping - see freight notes	#REF!
#REF!	Volleyball	10	21	Deluxe 15 Ball Carrier - Red #BBC-12RD	Jaypro	#BBC-12RD	EACH	\$ 110.000	5.0%	\$ 5.500	\$ 104.500	+ shipping - see freight notes	#REF!
#REF!	Volleyball	10	21	Deluxe 21 Ball Carrier - Royal Blue #BBC-18RB	Jaypro	#BBC-18RB	EACH	\$ 145.000	5.0%	\$ 7.250	\$ 137.750	+ shipping - see freight notes	#REF!
#REF!	Volleyball	10	21	Deluxe 21 Ball Carrier - Black #BBC-18BK	Jaypro	#BBC-18BK	EACH	\$ 145.000	5.0%	\$ 7.250	\$ 137.750	+ shipping - see freight notes	#REF!
#REF!	Volleyball	10	21	Deluxe 21 Ball Carrier - Red #BBC-18RD	Jaypro	#BBC-18RD	EACH	\$ 145.000	5.0%	\$ 7.250	\$ 137.750	+ shipping - see freight notes	#REF!
#REF!	Volleyball	10	21	Worm Drive Winch #PVBWINCH	Jaypro	#PVBWINCH	EACH	\$ 364.000	5.0%	\$ 18.200	\$ 345.800	+ shipping - see freight notes	#REF!
#REF!	Volleyball	10	21	Cargo Buckle Winch #HMS044	Jaypro	#HMS044	EACH	\$ 81.000	5.0%	\$ 4.050	\$ 76.950	+ shipping - see freight notes	#REF!
#REF!	Volleyball	10	21	Leader Strap (for #HMS044) #PVB101A	Jaypro	#PVB101A	EACH	\$ 57.000	5.0%	\$ 2.850	\$ 54.150	+ shipping - see freight notes	#REF!
#REF!	Volleyball	10	21	Leader Strap (for #PVBWINCH) #PVB603	Jaypro	#PVB603	EACH	\$ 67.000	5.0%	\$ 3.350	\$ 63.650	+ shipping - see freight notes	#REF!
#REF!	Volleyball	10	21	Winch Handle (for #PVBWINCH purchased after 2008) #VBW-HANDLE-08	Jaypro	#VBW-HANDLE-08	EACH	\$ 68.000	5.0%	\$ 3.400	\$ 64.600	+ shipping - see freight notes	#REF!
#REF!	Volleyball	10	21	Handle #PVB6071	Jaypro	#PVB6071	EACH	\$ 63.000	5.0%	\$ 3.150	\$ 59.850	+ shipping - see freight notes	#REF!
#REF!	Volleyball	10	21	Pin Chain Assembly (1500/5000/4500) #PVB512	Jaypro	#PVB512	EACH	\$ 17.000	5.0%	\$ 0.850	\$ 16.150	+ shipping - see freight notes	#REF!
#REF!	Volleyball	10	22	Volleyball Training Equipment - The Blocker #TB11	Jaypro	#TB11	EACH	\$ 275.000	5.0%	\$ 13.750	\$ 261.250	+ shipping - see freight notes	#REF!
#REF!	Volleyball	10	23	Double Play Sand Rake 24" Blade #12524	Midwest	#12524	EACH	\$ 67.950	5.0%	\$ 3.398	\$ 64.553	+ shipping - see freight notes	#REF!
#REF!	Volleyball	10	23	Double Play Sand Rake 36" Blade #12536	Midwest	#12536	EACH	\$ 79.950	5.0%	\$ 3.998	\$ 75.953	+ shipping - see freight notes	#REF!
#REF!	Volleyball	10	23	Sand Rake 24" Blade #12024	Midwest	#12024	EACH	\$ 64.950	5.0%	\$ 3.248	\$ 61.703	+ shipping - see freight notes	#REF!
#REF!	Volleyball	10	23	Sand Rake 30" Blade #12030	Midwest	#12030	EACH	\$ 68.950	5.0%	\$ 3.448	\$ 65.503	+ shipping - see freight notes	#REF!
#REF!	Volleyball	10	23	Sand Rake 36" Blade #12036	Midwest	#12036	EACH	\$ 70.950	5.0%	\$ 3.548	\$ 67.403	+ shipping - see freight notes	#REF!
#REF!	Volleyball	10	23	Sand Rake 42" Blade #12042	Midwest	#12042	EACH	\$ 77.950	5.0%	\$ 3.898	\$ 74.053	+ shipping - see freight notes	#REF!
#REF!	Volleyball	10	23	Sand Rake 48" Blade #12048	Midwest	#12048	EACH	\$ 82.950	5.0%	\$ 4.148	\$ 78.803	+ shipping - see freight notes	#REF!
#REF!	Volleyball	10	23	Loop Hoe Edger #42100	Midwest	#42100	EACH	\$ 37.950	5.0%	\$ 1.898	\$ 36.053	+ shipping - see freight notes	#REF!
#REF!	Volleyball	10	23	Sifting Scoop #49510	Midwest	#49510	EACH	\$ 115.950	5.0%	\$ 5.798	\$ 110.153	+ shipping - see freight notes	#REF!
#REF!	Volleyball	10	24	ST-4000 Premier Microfiber Volleyball #VBST4000	Champro	#VBST4000	EACH	\$ 29.950	5.0%	\$ 1.498	\$ 28.453	Delivered prices to 48 contiguous states, min. order of \$100 waived for bid customers	#REF!
#REF!	Volleyball	10	24	ST-2500 Premier Volleyball #VBST2500	Champro	#VBST2500	EACH	\$ 21.950	5.0%	\$ 1.098	\$ 20.853	Delivered prices to 48 contiguous states, min. order of \$100 waived for bid customers	#REF!
#REF!	Volleyball	10	25	ST-700 Pro Perform Volleyball #VB-ST700	Champro	#VB-ST700	EACH	\$ 13.950	5.0%	\$ 0.698	\$ 13.253	Delivered prices to 48 contiguous states, min. order of \$100 waived for bid customers	#REF!
#REF!	Volleyball	10	25	VB-LITE Training Series Featherlite Volleyball #VBL2	Champro	#VBL2	EACH	\$ 14.950	5.0%	\$ 0.748	\$ 14.203	Delivered prices to 48 contiguous states, min. order of \$100 waived for bid customers	#REF!
#REF!	Volleyball	10	25	ST-300 Competition Rubber Volleyball #VB41	Champro	#VB41	EACH	\$ 9.950	5.0%	\$ 0.498	\$ 9.453	Delivered prices to 48 contiguous states, min. order of \$100 waived for bid customers	#REF!
#REF!	Volleyball	10	25	ST200 Pro Performance Volleyball #VB-ST200	Champro	#VB-ST200	EACH	\$ 12.250	5.0%	\$ 0.613	\$ 11.638	Delivered prices to 48 contiguous states, min. order of \$100 waived for bid customers	#REF!
#REF!	Volleyball	10	various	A service charge of \$7.50 shall be added to all orders of less than \$100. #CHSC	Champro	CHSC	EACH	\$ 7.500			\$ 7.500	SERVICE CHARGED WAIVED FOR BID CUSTOMERS	#REF!
#REF!	Volleyball	10	26	DRI-BALL KIT #DB-KIT	Partac Peat Corporation	DB-KIT	EACH	\$ 75.000	5.0%	\$ 3.750	\$ 71.250	+ shipping - see freight notes	#REF!